



Allen-Bradley

ArmorPoint I/O DeviceNet Adapters

1738-ADN12, 1738-ADN18,
1738-ADN18P, 1738-ADNX

User Manual

**Rockwell
Automation**

Important User Information

Solid state equipment has operational characteristics differing from those of electromechanical equipment. *Safety Guidelines for the Application, Installation and Maintenance of Solid State Controls* (Publication SGI-1.1 available from your local Rockwell Automation sales office or online at <http://www.ab.com/manuals/gi>) describes some important differences between solid state equipment and hard-wired electromechanical devices. Because of this difference, and also because of the wide variety of uses for solid state equipment, all persons responsible for applying this equipment must satisfy themselves that each intended application of this equipment is acceptable.

In no event will Rockwell Automation, Inc. be responsible or liable for indirect or consequential damages resulting from the use or application of this equipment.

The examples and diagrams in this manual are included solely for illustrative purposes. Because of the many variables and requirements associated with any particular installation, Rockwell Automation, Inc. cannot assume responsibility or liability for actual use based on the examples and diagrams. No patent liability is assumed by Rockwell Automation, Inc. with respect to use of information, circuits, equipment, or software described in this manual. Reproduction of the contents of this manual, in whole or in part, without written permission of Rockwell Automation, Inc. is prohibited.

Throughout this manual, when necessary we use notes to make you aware of safety considerations.

WARNING

Identifies information about practices or circumstances that can cause an explosion in a hazardous environment, which may lead to personal injury or death, property damage, or economic loss.

IMPORTANT

Identifies information that is critical for successful application and understanding of the product.

ATTENTION

Identifies information about practices or circumstances that can lead to personal injury or death, property damage, or economic loss. Attentions help you:

- identify a hazard
 - avoid a hazard
 - recognize the consequence
-

SHOCK HAZARD

Labels may be located on or inside the equipment (e.g., drive or motor) to alert people that dangerous voltage may be present.

BURN HAZARD

Labels may be located on or inside the equipment (e.g., drive or motor) to alert people that surfaces may be dangerous temperatures.

Purpose of This Manual

This manual describes how to install, configure, and operate your ArmorPoint I/O™ DeviceNet™ Adapters, catalog numbers 1738-ADN12, -ADN18, -ADN18P, and -ADNX.

See the following sections:	Page:
Who Should Use This Manual	P-2
What the Manual Contains	P-2
Related Terms	P-3
Related Products and Documentation	P-5
Guidelines for Using Your Adapter	P-6
Conventions Used in This Manual	P-6

IMPORTANT

In this manual, we use ArmorPoint DeviceNet adapters to refer to all the 1738 DeviceNet adapter modules (1738-ADN12, -ADN18, -ADN18P, and -ADNX). We use the specific catalog number (e.g., 1738-ADNX) to refer to a specific module.

In the rest of this manual (except Chapter 4), we refer to the ArmorPoint I/O DeviceNet adapters as the adapters.

In Chapter 4, we refer to the ArmorPoint I/O DeviceNet adapter as the scanner because the chapter describes how to configure the adapter on the subnet.

Who Should Use This Manual

You must be able to use RSNWorx for DeviceNet™ software or a similar configuration software to configure your adapter.

In this manual, we assume you know how to configure an adapter. If you do not, refer to your software user manuals or online help before attempting to use these adapters.

We also assume you are familiar with the ArmorPoint I/O product line, including other fieldbus interfaces, I/O modules, and power supplies. If you are not familiar with these components, you can read some of the ArmorPoint I/O documents listed in the Related Products and Documentation section.

What the Manual Contains

This manual contains the following sections:

Chapter 1 - Install the ArmorPoint DeviceNet Adapters

Description of how to install and wire the adapter

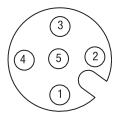

Chapter 2 - What Is the ArmorPoint DeviceNet Adapter?

Overview of the adapter's features and functionality

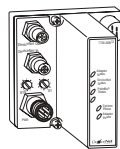

Chapter 3 - Use Auto Start Mode

Description of how to use the Auto Start Mode on your adapter to quickly get your system up and running

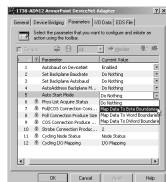

Or

Chapter 4 - Configure the DeviceNet Scanner Subnet

Description of how to configure your adapter on the subnet

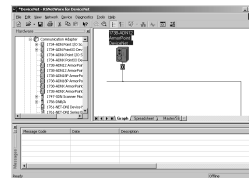

Chapter 5 - Add the ArmorPoint DeviceNet Adapter to the DeviceNet Scanner's Scanlist

Description of how to configure the DeviceNet adapter and how to add it to the scanlist

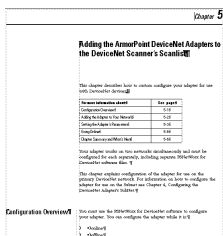

Chapter 6 - Troubleshoot the ArmorPoint DeviceNet Adapter

Description of how to use the status indicators and how to troubleshoot your adapter

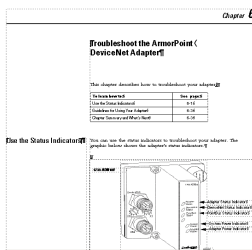

Appendix A - Specifications

Listing of the ArmorPoint adapters' specifications



Appendix B - Quick Start

Learning how to use the 1738-ADN12 with a ControlLogix system on DeviceNet

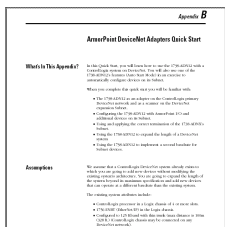

Appendix C - 1738-ADNX Rules and Guidelines

Rules and guidelines regarding how to use the 1738-ADNX

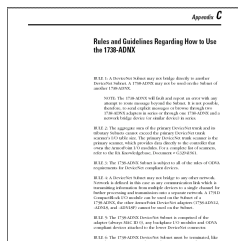

Appendix D - Default Data Maps

Listing of the default data maps for 1738 ArmorPoint I/O modules

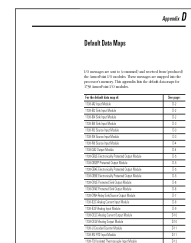

Related Terms

This manual uses the following terms:

Term:	Definition:
Adapter	The adapter interfaces between DeviceNet devices and ArmorPoint I/O modules. ArmorPoint I/O DeviceNet adapters include the 1738-ADN12, -ADN18, -ADN18P, and -ADNX.
Auto Catalog Replace	The ArmorPoint I/O DeviceNet adapter supports the swapping of two identical modules connected to the adapter. That is, if a 1738-IB4M12 is in slot 3 and another 1738-IB4M12 is in slot 7, the two modules can be removed from the ArmorPoint system and the slot 3 module placed into slot 7, and vice-versa. When Automatic Device Replacement (ADR) is active, the swapped modules will be reconfigured to match the previous module in their new slot. When ADR is not active, the configuration parameters will not be modified, the swapped modules must have identical configuration and values for their EDS file parameters.
Auto Device Replacement (ADR)	This refers to the ADR feature of a ControlLogix System on DeviceNet. With ADR active, any device on the DeviceNet link may be removed and replaced with an out-of-the-box checkmark compliant DeviceNet device. The ADR feature will result in downloading the values of the configuration parameters of the EDS file of the removed device to the new device.
Auto Start Mode	A feature that lets the ArmorPoint I/O system get "up and running" without the prerequisite to configure any of the EDS parameters for the PointBus™ or ArmorPoint I/O modules. Using Auto Start Mode will result in a scan list within the adapter that stores the modules identity information.
Autobaud	A feature in devices (e.g., ArmorPoint I/O modules) on the DeviceNet network that causes them to listen to communications on the network and set their own baudrate to match the network rate.
Backplane	The PointBus that consists of ArmorPoint I/O modules connected to the ArmorPoint DeviceNet adapter.
Baudrate	Rate of communications between devices on the DeviceNet network. Backplane baudrate is used for the 1738-ADN12, -ADN18, and -ADN18P. Subnet baudrate is used for the 1738-ADNX.
Change of State (COS)	DeviceNet communications method in which the adapter sends data based on detection of any changed value within the input data. Data is independently received based on a change of state from the sender. Data in both directions can be acknowledged or unacknowledged depending on the run-time configuration of the system.
Commissioning	The period in time associated with post startup activities. Commissioning implies that the system has been validated and all configuration parameters are correct, all modules are in good operating condition, and the adapter scanlist is complete.
ControlFlash™	Utility software you can use to update the adapter's firmware with the most current boot and application code.

Term:	Definition:
Cyclic	DeviceNet communications method in which the adapter sends data cyclically based on a configured time value. Data is independently received cyclically from the sender. Data in both directions can be acknowledged or unacknowledged depending on the run time configuration of the system.
MACID	Media Access Control Identifier (DeviceNet network address).
Master	A DeviceNet network device (e.g., 1771-SDN) that initiates communication with DeviceNet slave devices (e.g., ArmorPoint I/O modules) to retrieve data. The master only receives unprompted data when the slave is enabled for COS and there is a change in the device's operating state.
Max Backplane MACID	The 1738-ADNX has a unique attribute, Max(imum) Backplane MACID . This value represents the highest node address of a module residing on the backplane. This value must be greater than or equal to the right most backplane ArmorPoint I/O module, but must be less than that of any non-backplane Subnet module .
Offline	State of the adapter when it is not powered or maintaining normal communication exchanges with other DeviceNet devices.
Online	State of the adapter when it is powered and maintaining normal communication exchanges with other DeviceNet devices.
PointBus	The ArmorPoint I/O backplane PointBus maintains all DeviceNet network protocol but also offers configuration capabilities.
Polled	DeviceNet communications method in which a module sends data in response to received data.
Primary Network	The primary DeviceNet network is defined as the DeviceNet link that provides the direct connection between the ArmorPoint DeviceNet adapter and a DeviceNet scanner.
RSNetWorx for DeviceNet	Configuration software for the adapter and Subnet modules.
Scanlist	The list of Subnet modules connected to the adapter. When ADR is active, the scanlist stores the configured values of each of the Subnet modules' configurable parameters. When ADR is not active, the scanlist stores only the module identity information.
Scanner	Operating state of the ArmorPoint DeviceNet adapter when it retrieves I/O data from Subnet modules.
Slave	A DeviceNet network device that cannot initiate communication (except when configured with COS enabled) but responds to a DeviceNet master device.
Strobe	Adapter sends data in response to the strobe command. The single bit allocated to the adapter in the strobe message is not used. If the configured size of the input data (sent from the adapter) is greater than 8 bytes, the strobe connection establishment will fail. In this case, the input size must be reconfigure to 8 bytes or less.

Term:	Definition:
Subnet	1738-ADNX only. The Subnet DeviceNet network is defined as the DeviceNet link that provides the expansion of the PointBus to let the 1738-ADNX use its lower connector to add an additional 500 meters and up to 63 nodes. These nodes will be bridged through the 1738-ADNX up to the primary network. Note that backplane modules are also part of the Subnet.

Related Products and Documentation

The following table lists related ArmorPoint I/O products and documentation:

Description	Cat. No.	Publication
ArmorPoint 24V dc Output Modules Installation Instructions	1738-OB2E, -OB2EP, -OB4E, -OV4E, -OB8E	1738-IN001
ArmorPoint 24V dc Input Modules Installation Instructions	1738-IB2, IB4, -IV4, -IB8, -IV8	1738-IN002
ArmorPoint 24V dc Analog Input Modules Installation Instructions	1738-IE2C, -IE2V	1738-IN003
ArmorPoint 24V dc Analog Output Modules Installation Instructions	1738-OE2C, -OE2V	1738-IN004
ArmorPoint RTD and Thermocouple Modules Installation Instructions	1738-IR2, -IT2I	1738-IN005
ArmorPoint AC Input Modules Installation Instructions	1738-IA2M12AC3, -IA2M12AC4	1738-IN006
ArmorPoint AC Output Module Installation Instructions	1738-OA2M12AC3	1738-IN007
ArmorPoint Relay Output Modules Installation Instructions	1738-OW4M12, -OW4M12AC	1738-IN008
ArmorPoint RS232 ASCII Module Installation Instructions	1738-232ASCM12	1738-IN009
ArmorPoint RS485 ASCII Module Installation Instructions	1738-485ASCM12	1738-IN010
ArmorPoint 24V dc VHSC Module Installation Instructions	1738-VHSC24M23	1738-IN011
ArmorPoint 5V dc Incremental Encoder Module Installation Instructions	1738-IJM23	1738-IN012
ArmorPoint SSI Module Installation Instructions	1738-SSIM23	1738-IN013
ArmorPoint DeviceNet Adapters Installation Instructions	1738-ADN12, -ADN18, -ADN18P, -ADNX	1738-IN014
ArmorPoint PROFIBUS Adapter Installation Instructions	1738-APB	1738-IN015
ArmorPoint PROFIBUS Adapter User Manual		1738-UM002
ArmorPoint ControlNet Adapter Installation Instructions	1738-ACNR	1738-IN016
ArmorPoint ControlNet Adapter User Manual		1738-UM003
ArmorPoint EtherNet/IP Adapter Installation Instructions	1738-AENT	1738-IN017
ArmorPoint EtherNet/IP Adapter User Manual		1738-UM004
ArmorPoint Extension Units Installation Instructions	1738-EXT1, -EXT3	1738-IN018
ArmorPoint Field Potential Distributor Installation Instructions	1738-FPD	1738-IN019
ArmorPoint I/O 24V dc Expansion Power Supply Installation Instructions	1738-EP24DC	1738-IN020
DeviceNet Media Design & Installation Guide	N/A	DNET-UM072
Industrial Automation Wiring and Grounding Installation Instructions	N/A	1770-4.1

If you need more information on these products, contact your local Rockwell Automation/Allen-Bradley distributor, integrator or sales office for assistance. For more information on the documentation, refer to the Allen-Bradley Publication Index, publication SD499.

Guidelines for Using Your Adapter

Remember the following operational guidelines when using your ArmorPoint DeviceNet adapter.

- Do not leave spaces in the I/O. Instead, install all ArmorPoint I/O modules adjacent to each other.
- Populate every position on the mounting base.
- ArmorPoint does not support removal and insertion under power (RIUP). When an I/O module is removed, the IP67 seal is broken and the backplane bus is interrupted.
- Use Allen-Bradley terminal markers to identify your ArmorPoint I/O modules.

For more information on the Allen-Bradley terminal marking kits, see the documents list on page Preface-5.

Conventions Used In This Manual

The following conventions are used throughout this manual:

- bullet lists (such as this one) provide information, not procedural steps
- numbered lists provide sequential steps
- text **written like this** identifies screen, menu, toolbar names, field names, buttons, and check boxes on screens
- a menu item in this format **File>Save** identifies the submenu item after the caret (>) that is accessed from the main menu (name before the caret)
- pictures of symbols and/or screens represent the actual symbols you see or the screens you use

	Chapter 1	
Install the ArmorPoint DeviceNet Adapters	Mount the Adapter and I/O Base	1-1
	Set the Node Address	1-2
	Wire the DeviceNet Adapters.	1-3
	1738-ADN12 and 1738-ADNX.	1-3
	1738-ADN18 and 1738-ADN18P	1-3
	1738 ArmorPoint DeviceNet Auxiliary Power	1-4
	Chapter Summary and What's Next	1-4
	Chapter 2	
What Is the ArmorPoint DeviceNet Adapter?	Use the Adapter	2-2
	Set Subnet/Backplane Baudrate	2-3
	Set Subnet/Backplane I/O Module Addresses	2-3
	Configure the Subnet I/O.	2-3
	Configure the Primary DeviceNet Network	2-4
	Remove and Reinsert Modules on the Backplane	2-5
	Understand the DeviceNet Network and Subnet.	2-6
	DeviceNet Network	2-6
	Backplane/Subnet Network	2-7
	Adapter Features.	2-8
	Communicate Through the Adapter.	2-18
	Map the Data.	2-18
	Overview of the Communication Process	2-19
	Image Table Mapping	2-20
	Communicate With I/O Modules	2-23
Use Diagnostic Tables	2-24	
Chapter Summary and What's Next	2-26	
	Chapter 3	
Use Auto Start Mode	Why Use Auto Start Mode?	3-2
	What Does Auto Start Mode Do?.	3-2
	How Is I/O Data Mapped Using Auto Start Mode?.	3-3
	Requirement To Using Auto Start Mode	3-4
	Install the I/O Module.	3-4
	Remove the Module From the Mounting Base.	3-5
	Use RSNetWorx for DeviceNet.	3-5
	Begin Auto Start Mode	3-7
	Use Custom Configuration.	3-9
Chapter Summary and What's Next	3-10	

	Chapter 4	
Configure the DeviceNet Scanner Subnet	Configuration Overview	4-1
	Add the Scanner To Your Network	4-2
	Add I/O Modules To Your Network	4-3
	Set the Scanner's Parameters.	4-3
	Go On Line	4-8
	Chapter Summary and What's Next	4-8
	Chapter 5	
Add the ArmorPoint DeviceNet Adapter to the DeviceNet Scanner's Scanlist	Configuration Overview	5-1
	Add the Adapter to Your Network	5-2
	Set the Adapter's Parameters.	5-3
	Go On Line	5-6
	Chapter Summary	5-6
	Chapter 6	
Troubleshoot the ArmorPoint DeviceNet Adapter	Use the Status Indicators	6-1
	Guidelines for Using Your Adapter	6-3
	Chapter Summary	6-3
Specifications	Appendix A	
	Appendix B	
Quick Start For the 1738-ADNX	What's In This Appendix?	B-1
	Assumptions	B-1
	Review of the 1738-ADNX Rules and the MACID Parameter	B-9
	Review of Auto Start Mode.	B-11
	Browse the Subnet	B-15
	Inputs and Outputs	B-19
	Navigate Between Networks.	B-24
Rules and Guidelines For the 1738-ADNX	Appendix C	

Default Data Maps

Appendix D

1738-IA2 Input Module D-2
1738-IB2 Sink Input Module D-2
1738-IB4 Sink Input Module D-2
1738-IB8 Sink Input Module D-3
1738-IV4 Source Input Module D-3
1738-IV8 Source Input Module D-3
1738-OA2 Output Module D-4
1738-OB2E Electronically Protected Output Module . . . D-4
1738-OB2EP Protected Output Module D-4
1738-OB4E Electronically Protected Output Module . . . D-5
1738-OB8E Electronically Protected Output Module . . . D-5
1738-OV4E Protected Sink Output Module D-6
1738-OW4 Relay Sink/Source Output Module D-6
1738-IE2C Analog Current Input Module D-7
1738-IE2V Analog Input Module D-8
1738-OE2C Analog Current Output Module D-9
1738-OE2V Analog Output Module D-9
1738-IJ Encoder/Counter Module D-10
1738-IR2 RTD Input Module D-10
1738-IT2I Isolated Thermocouple Input Module D-11
1738-VHSC 24V dc High Speed Counter Module D-12
1738-SSI Synchronous Serial Interface Absolute
Encoder Module D-12
1738-232ASC ASCII Module D-13
1738-485ASC ASCII Module D-13

Install the ArmorPoint DeviceNet Adapters

This chapter describes how to install and wire your adapter.

See the following sections:	Page:
Mount the Adapter and I/O Base	1-1
Set the Node Address	1-2
Wire the DeviceNet Adapters	1-3
Chapter Summary and What's Next	1-4

Mount the Adapter and I/O Base

To mount the ArmorPoint adapter on a wall or panel, use the screw holes provided in the adapter.

A mounting illustration for the ArmorPoint adapter with I/O bases is shown below.

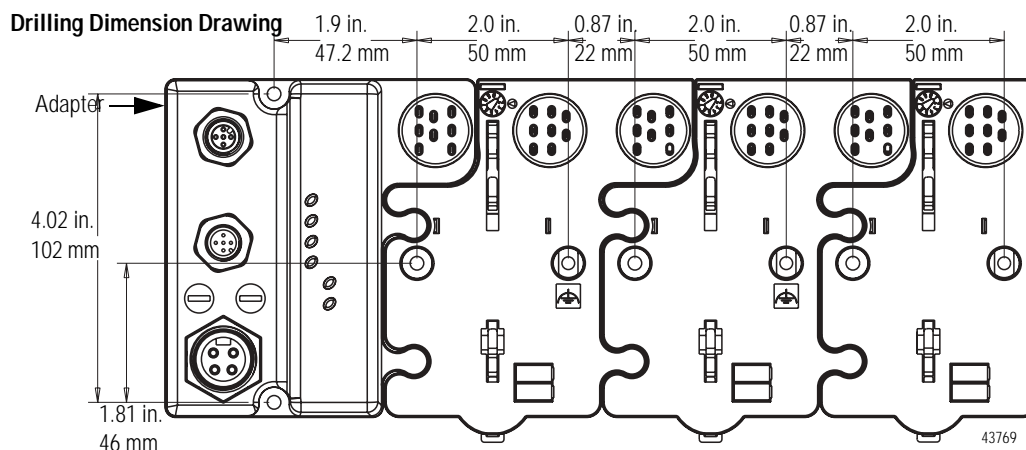

Install the mounting base as follows:

1. Lay out the required points as shown in the drilling dimension drawing.
2. Drill the necessary holes for #8 (M4) machine or self-tapping screws.
3. Mount the adapter and I/O bases using #8 (M4) screws.
4. Ground the system using the ground lug connection in the I/O base. (The ground lug connection is also a mounting hole.)

5. Mount the terminating base that was shipped with the adapter as the last base in the backplane instead of the base that was shipped with the I/O module.

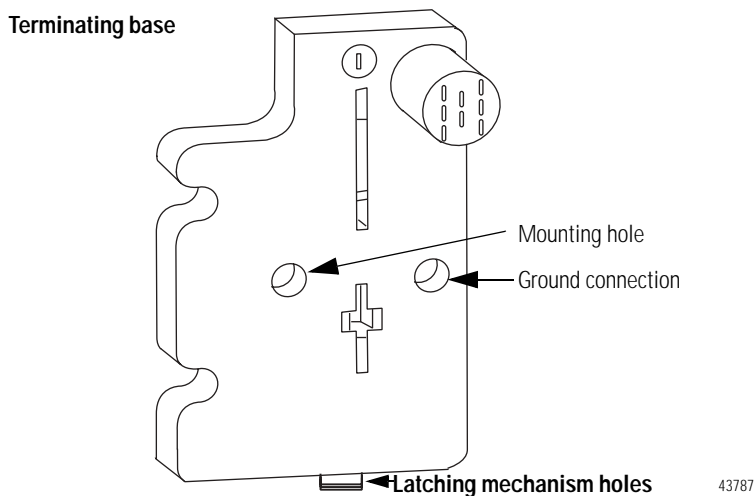

Set the Node Address

Valid node addresses are **00** through **63**.

Set the node address using either the rotary switches, RSNetWorx for DeviceNet, DeviceNetManager™, or another software configuration tool. Setting the switches at any number from **64** through **99** lets the software have address control.

Each module is shipped with the switches set for node address **63**. Remove the caps on the front of the module to access the switches (refer to the X10 and X1 on the front of the module). The two switches are:

- X10 (most significant digit) - left side of module
- X1 (least significant digit) - right side of module

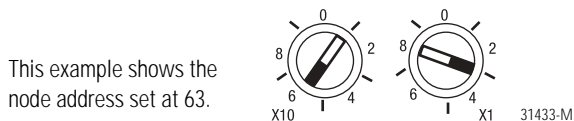

To reset the node address, use a small blade screwdriver to rotate the switches. Line up the small notch on the switch with the number setting you wish to use and then cycle power.

The rotary switches are read periodically. If the switches have been changed since the last time they were read and they no longer match the on line address, a minor fault will occur, which is indicated by a flashing red Adapter Status LED. Settings of 64 through 99 cause the module to use the last valid node address stored internally. For example, the last setting internally was 40. If a change is made to 68, and then you power up, the address will default to 40.

The module is equipped with AutoBaud detect. AutoBaud lets the module read the settings already in use on your DeviceNet network and automatically adjusts to follow those settings.

Wire the DeviceNet Adapters

Following are wiring instructions for the ArmorPoint DeviceNet adapters.

1738-ADN12 and 1738-ADNX

Male In Connector

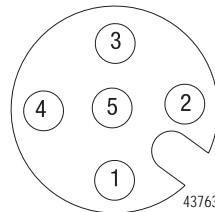

Female Out Connector (1738-ADN12)
(Subnet Out - 1738-ADNX only)

(view into connector)

- Pin 1 - Drain
- Pin 2 - +V
- Pin 3 - -V
- Pin 4 - CAN_High
- Pin 5 - CAN_Low

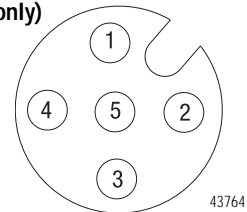

1738-ADN18 and 1738-ADN18P

Male In Connector

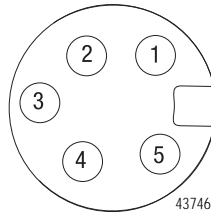

Female Out Connector
(1738-ADN18P only)

(view into connector)

- Pin 1 - Drain
- Pin 2 - +V
- Pin 3 - -V
- Pin 4 - CAN_High
- Pin 5 - CAN_Low

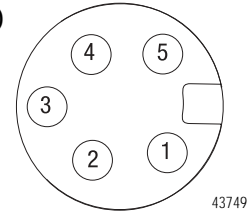

1738 ArmorPoint DeviceNet Auxiliary Power

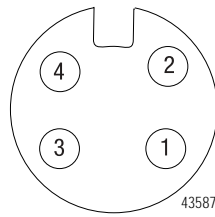

Male In Connector

(view into connector)

Pin 1 - User Power +

Pin 2 - Adapter Power +

Adapter/Subnet + (1738-ADNX only)

Pin 3 - Adapter Power -

Adapter/Subnet - (1738-ADNX only)

Pin 4 - User Power -

ATTENTION



Make sure all connectors and caps are securely tightened to properly seal the connections against leaks and maintain IP67 requirements.

Chapter Summary and What's Next

In this chapter, you learned how to install and wire your DeviceNet adapter. Move to chapter 2 to learn about the ArmorPoint DeviceNet adapters.

What Is the ArmorPoint DeviceNet Adapter?

This chapter describes the ArmorPoint I/O DeviceNet adapter, including descriptions of the adapter's features and functionality.

See the following sections:	Page:
Use the Adapter	2-2
Understand the DeviceNet Network and Subnet	2-6
Adapter Features	2-8
Communicate Through the Adapter	2-18
Communicate With I/O Modules	2-23
Use Diagnostic Tables	2-24
Chapter Summary and What's Next	2-26

Use the Adapter

The adapter resides on the primary DeviceNet network and the Subnet simultaneously.

IMPORTANT

The PointBus maintains all DeviceNet network protocol but also offers configuration capabilities.

The adapter interfaces between DeviceNet devices and ArmorPoint I/O modules. The graphic below shows the adapter on the DeviceNet network and PointBus.

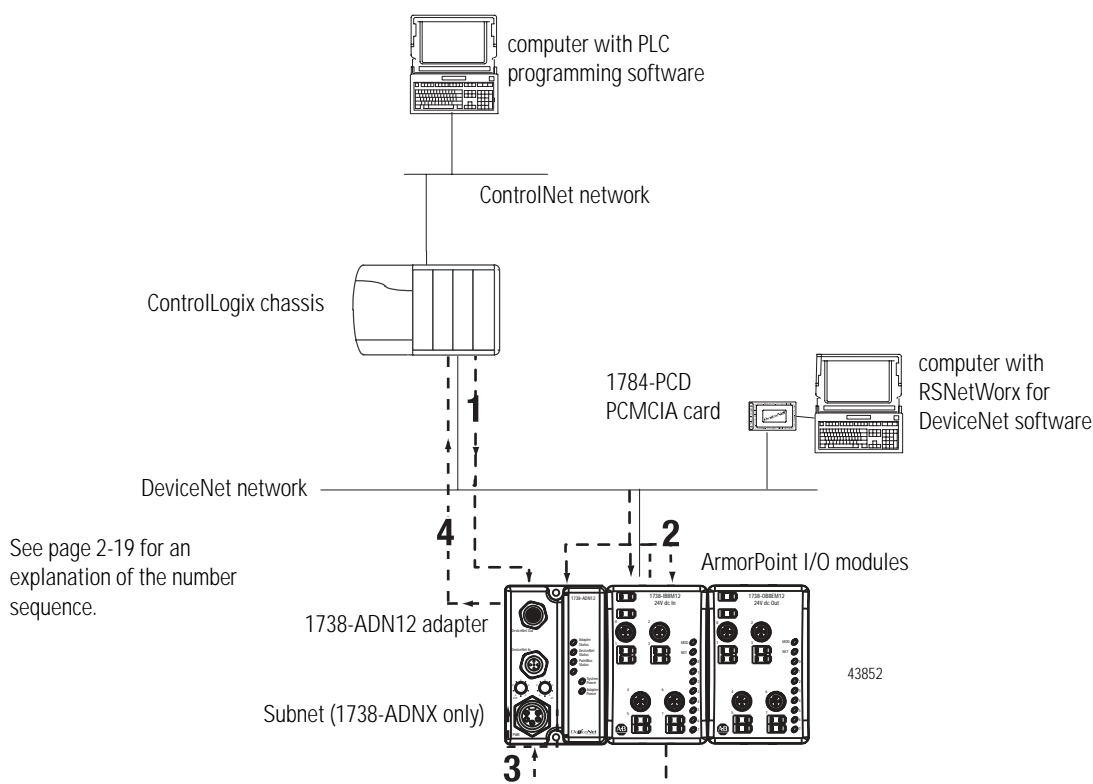

After you have installed your adapter into a ArmorPoint I/O system, you must perform the following tasks:

1. Set Subnet/Backplane Baudrate
2. Set Subnet/Backplane I/O Module Addresses
3. Configure the Subnet I/O
4. Configure the Primary DeviceNet Network

The steps mentioned above are explained briefly here and then in greater detail throughout this manual. You must complete the steps for the adapter to work with DeviceNet masters (e.g., 1756-DNB) on the primary network and Subnet modules.

1. Set Subnet/Backplane Baudrate

The adapter and Subnet/Backplane modules must use the same baudrate to communicate with each other. Use one or both of the following to set a Subnet/Backplane baudrate.

- Enable or disable the Backplane Autobaud feature for ArmorPoint I/O modules. ArmorPoint I/O modules have Autobaud enabled as the default- See page 2-12.
- Set the adapter baudrate for the Subnet. The default for the 1738-ADN12, -ADN18, and -ADN18P is 1Mbaud. The default for the 1738-ADNX is 125Kbaud - See page 2-9.

You set the backplane baudrate for the 1738-ADN12, -ADN18, and -ADN18P. You set the Subnet baudrate for the 1738-ADNX.

2. Set Subnet/Backplane I/O Module Addresses

Once the adapter and ArmorPoint I/O modules are communicating at the same rate on the backplane, you must make sure all modules use a valid MACID.

Set the Auto Address feature for ArmorPoint I/O modules - See page 2-13.

For the 1738-ADNX, a DeviceNet configuration tool, such as RSNetWorx for DeviceNet, may be required to set the node address. (if node address switches are not present on the Subnet device).

3. Configure the Subnet I/O

In the first two steps, you set a consistent communication rate and made sure each module uses valid addresses for communication. Next you must configure the PointBus (e.g., set scan list).

You can configure the PointBus using one of two methods:

- Auto Start Mode (ASM) or
- Manually

For more information on configuring the PointBus, see Chapter 3 for ASM or see Chapter 4 for manual configuration.

4. Configure the Primary DeviceNet Network

Finally, you must configure the adapter for communication with a master (e.g., 1756-DNB).

For more information on configuring the DeviceNet network, see Chapter 5, Add the ArmorPoint DeviceNet Adapter to the DeviceNet Scanner's Scanlist.

You must understand all of the adapter's features to effectively use it in your ArmorPoint I/O system. Keep these four steps in mind as you read this manual:

1. Set Subnet/Backplane Baudrate
2. Set Subnet/Backplane I/O Module Addresses
3. Configure the Subnet I/O
4. Configure the Primary DeviceNet Network

Remove and Reinsert Modules on the Backplane

Removal and Insertion Under Power (RIUP) is not recommended in a ArmorPoint System because of the following reasons.

- Removing a module breaks the IP67 seal.
- Removing a module breaks the backplane bus. Modules to the right of the removed module will be 'lost' to the adapter. Also, the terminating resistor will be removed, causing system uncertainty.
- Inserting a module under power may cause the adjacent module to reset due to the addition of a large capacitive load on the power bus.

IMPORTANT

If the module is removed while it is under power, all the modules to the right of the removed module will disconnect from the PointBus and field power until the module is reinstalled.

If you must remove and reinsert modules, we recommend the following:

- Do not move I/O modules to different locations on the mounting base after they have been installed and configured.
- If adjacent modules (i.e., 2 or more) are removed from the backplane, replace all of them before attempting to operate the ArmorPoint I/O system. Input data will hold last state until all previously removed modules are replaced.
 - If adjacent modules are removed and all but one is returned, the adapter cannot verify the location of the returned modules. For example, if modules are removed from nodes 3 and 4 and only the module from node 4 is returned, the adapter cannot verify the location. In this case, the adapter alerts you via a flashing red PointBus status LED that it cannot verify the presence of modules in the affected locations. I/O data will not be exchanged with this node until both modules have been reinserted.
 - If modules of **different types** are removed and returned to the wrong locations, the adapter identifies the returned modules and alerts you (via RSNetWorx for DeviceNet) that the error has occurred and must be corrected.

- If modules of the **same type** are removed and returned to the wrong locations, the adapter identifies the returned modules, updates their MACIDs, and continues operation.

IMPORTANT

The removal and return scenario exists whether the system is under power or not. If the system is under power, the scenario arises immediately. If the system is not under power, the scenario arises in the next power cycle.

Also, the example above shows removal of two adjacent modules. The scenario described exists anytime 2 or more adjacent modules are removed and all are not returned.

IMPORTANT

Care must be taken when replacing backplane I/O modules. Each I/O module stores its configuration parameters in internal non-volatile memory. You must either enable ADR for all modules or manually configure each module in a non-manufacturing environment when the module is being replaced or placed on the network for the first time. Failure to do so could result in inadvertent control attributed to different configuration settings.

Understand the DeviceNet Network and Subnet

DeviceNet Network

Your adapter serves as a slave to DeviceNet masters. The adapter receives data from and returns data to the master through the following I/O connections:

- Change of State (COS)
- Cyclic
- Polled
- Strobe

Backplane/Subnet Network

On the Backplane/Subnet, your adapter acts as a scanner and is the master of the Subnet modules. The adapter performs the following functions:

- Exchanges I/O data with devices on the Backplane/Subnet
- Collects I/O data from the Backplane/Subnet and sends it to devices on the DeviceNet network (e.g., scanners or controllers)
- Supplies power to the backplane I/O modules (See Appendix A for power supply rules regarding I/O modules power requirements.)

Data Collection

The adapter collects I/O data from up to 63 modules via the Backplane/Subnet. The I/O modules appear on the primary DeviceNet network as a single node, though, and require only one DeviceNet node address.

IMPORTANT

If Automatic Device Replacement (ADR) is enabled on the adapter, you can only connect up to 62 modules via the Subnet.

For more information on ADR, see page 2-15.

Module Power

The adapter supplies 5V logic power to ArmorPoint I/O modules by converting 24V dc field power to PointBus 5V power.

You can connect up to 63 I/O modules to each adapter and you can power the backplane I/O modules from the adapter (with a maximum of 10A of field power). You may use the integrated, isolated 24V dc expansion power unit (1738-EP24DC) to power additional I/O modules, as shown below.

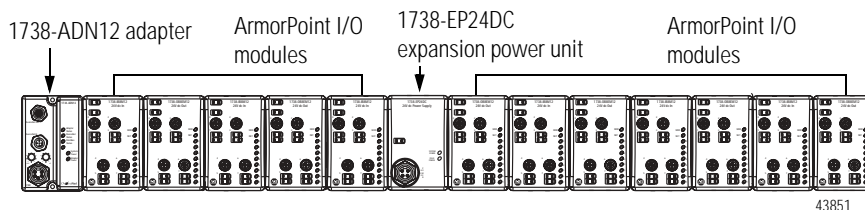

For more information on the 1738-EP24DC expansion power unit, see the ArmorPoint I/O 24V dc Expansion Power Supply Installation Instructions, publication 1738-IN020.

Adapter Features

Your adapter uses the following features on both the DeviceNet network and the PointBus:

- Self-Test
- Field Upgradable Firmware
- Fully Configurable Software
- Connections
- Baudrates

Self-Test

When power is applied to the adapter, the adapter performs a self-test. The adapter tests various internal and programmatic memories and checks the status indicators (LEDs).

Field Upgradable Firmware

You can update the adapter's firmware with the ControlFlash Utility software. This feature lets you always use the most current firmware.

Fully Software Configurable

The adapter is fully software configurable using RSNetWorx for DeviceNet. You must configure the adapter to be used with a DeviceNet master (e.g., 1756-DNB) and separately to be used with Subnet devices.

For more information on how to configure your adapter to use with a DeviceNet master, see Chapter 5, Add the ArmorPoint DeviceNet Adapter to the DeviceNet Scanner's Scanlist.

For more information on how to configure your adapter to use with Subnet modules, see Chapter 4, Configure the DeviceNet Scanner Subnet.

Connections

Your adapter supports the following connections on both the primary DeviceNet network and Subnet:

- I/O connections:
 - Polled
 - Strobe
 - Cyclic
 - COS
- Explicit connections

You can use I/O mapping to determine the data contained in each connection.

The adapter supports Master/Slave connection types on the DeviceNet network. On the Subnet, the adapter functions as a scanner device, exchanging data with I/O modules.

Baudrates

Choose baudrates for the adapter in the RSNetWorx for DeviceNet software. The adapter supports these rates:

- 125Kbaud
- 250Kbaud
- 500Kbaud
- Autobaud - The adapter detects the primary DeviceNet network baudrate and automatically sets its own baudrate to match the network.
- For the 1738-ADN12, -ADN18, and -ADN18P, the PointBus can be configured to operate at 1Mbaud (1000Kbaud).
- For the 1738-ADNX, the Subnet can be configured to operate at 125K, 250K, and 500K baud only.

Auto Start Mode

Auto Start Mode lets you easily get your adapter installed and operating. In this mode, the adapter's configurable features operate as they were most recently configured. For example, if Autobaud on DeviceNet was enabled in the adapter's last configuration, it will be enabled when Auto Start Mode is used.

For a more detailed explanation of how to use Auto Start Mode, see Chapter 3.

Auto Catalog Replace

Auto Catalog Replace corrects errors that might occur when backplane modules of the same type are removed and replaced in the wrong location. If modules of the same type are removed and returned to the wrong locations, the adapter identifies the returned modules, updates their MAC IDs, and continues operation.

IMPORTANT

If modules of different types are removed and returned to the wrong locations, the adapter identifies the returned modules and alerts you (via RSNetWorx for DeviceNet, the Node Status Table, and the Faulted Node Table) that the error has occurred and must be corrected.

Backplane (1738-ADN12, -ADN18, -ADN18P)/Subnet (1738-ADNX) Baudrate

EDS parameter Backplane Baudrate is accessible from the primary DeviceNet and sets a specific baudrate for all backplane I/O modules.

Set this parameter in RSNetWorx for DeviceNet to one of the following baudrates:

- 125 Kbaud
- 250 Kbaud
- 500 Kbaud
- 1 Mbaud (available for all the ArmorPoint DeviceNet adapters except the 1738-ADNX)

When you download this parameter, the adapter sends a command to reset all present I/O modules on the backplane to the new baudrate. If additional modules are connected to the adapter, you must download the Backplane/Subnet Baudrate to make sure the new modules use the same rate as the others.

The baudrate may not take effect until power is recycled or the I/O modules are reset.

IMPORTANT

Changes to the Backplane/Subnet Baudrate parameter only take effect if they are downloaded on an individual basis. (For example, if you change the Backplane/Subnet Baudrate and download the changes with additional changes to other features, the Backplane/Subnet Baudrate remains at the previous setting.)

Also, this parameter should be set to 'Do Nothing' when you download all parameters or when Automatic Device Replacement is enabled for the adapter.

If you want to set an I/O module to use a specific baudrate (i.e., 125, 250, 500), you must first disable Backplane Autobaud for that module.

Backplane/Subnet Baudrate performs the following functions:

- Sets the adapter's Subnet baudrate
- Sends a message to all connected backplane I/O modules. If an I/O module is set to autobaud, it receives the message but ignores the new baudrate.

Backplane Autobaud

The adapter itself never autobauds on the Subnet. Backplane Autobaud automatically enables or disables Autobaud for all I/O modules currently attached to the backplane. The adapter does not set a specific rate though (as with Backplane Baudrate).

If you enable Backplane Autobaud in the adapter or the EDS parameter access that you set from the primary DeviceNet, the adapter only enables the Autobaud in all backplane I/O modules. When the modules listen to communications on the DeviceNet network, they detect the rate of communication and automatically set their own baudrates to match the network rate.

The module does not automatically detect the backplane baudrate until power is cycled or the module is reset.

TIP

Autobaud, when enabled, is useful if you swap ArmorPoint I/O modules between networks that are operating at different baudrates.

Enable Backplane Baudrate in RSNetWorx for DeviceNet.

IMPORTANT

Changes to the Backplane Autobaud parameter only take effect if they are downloaded on an individual basis. (For example, if you enable the Backplane Autobaud setting and download the change with additional changes to other features, the Backplane Baudrate remains disabled.)

This parameter should be set to 'Do Nothing' when you download all parameters or when Automatic Device Replacement is enabled for the adapter.

If you want to set an I/O module to use a specific baudrate (i.e., 125, 250, 500), you must first disable Autobaud for that module.

Auto Address

The EDS parameter Auto Address is available from the primary DeviceNet and lets the user sequentially order the node addresses of backplane I/O modules. This parameter is not a mode but occurs on a single occurrence only. The node address selected is assigned to the module closest to the adapter. The next closest module is assigned the next numerically higher value. The numbering pattern continues for all connected backplane I/O modules.

Enable this parameter in the RSNetWorx for DeviceNet software.

IMPORTANT

Changes to the Auto Address parameter only take effect if they are downloaded on an individual basis. (For example, if you enable the Auto Address and download the changes with additional changes to other features, the node addresses of the I/O modules remains disabled.)

This parameter should be set to 'Do Nothing' when you download all parameters or when Automatic Device Replacement is enabled for the adapter.

Physical List Acquire Status

The adapter maintains a physical list that indicates the order of the node addresses of all ArmorPoint I/O modules present on the backplane. Physical List Acquire Status shows the status of this physical list acquire process.

The adapter requires that each backplane I/O module has a MACID greater than that of its neighbor to its immediate left. The list is created when power is applied to the adapter and each time a module is inserted on the backplane.

The valid values are:

- Idle
- Busy
- Auto Start Mode

Cycling Node Status

Using the Cycling Node Status parameter, you can easily determine the status of any ArmorPoint I/O modules with which the adapter is experiencing problems. A corresponding text string appears, including the MAC ID, and a description of the status code reported in the Node Status Table. For more information on the Node Status Table, see page 2-24.

For the connection sizes mentioned below, the I/O connection sizes on DeviceNet are dependent on the scanlist configuration on the backplane.

Poll/COS Connection Consume Size

Poll/COS Connection Consume Size shows the size (number of data bytes) consumed by the poll/COS (Instance 2) I/O connection on the primary DeviceNet.

Poll Connection Produce Size

Poll Connection Produce Size shows the size (number of data bytes) produced by the polled (Instance 2) I/O connection on the primary DeviceNet.

COS/Cyclic Connection Produce Size

COS Produce Size shows the size (number of data bytes) produced by the Change of State I/O connection on the primary DeviceNet.

Strobe Connection Produce Size

The Strobe Produce Size shows the size (number of data bytes) produced by the Strobe I/O connection on the primary DeviceNet.

Cycling I/O Mapping

Cycling I/O Mapping is an EDS parameter accessible from the primary DeviceNet that shows you how data is mapped in the adapter's scanlist. The data, as shown below, is listed in order of active modules in the scanlist.

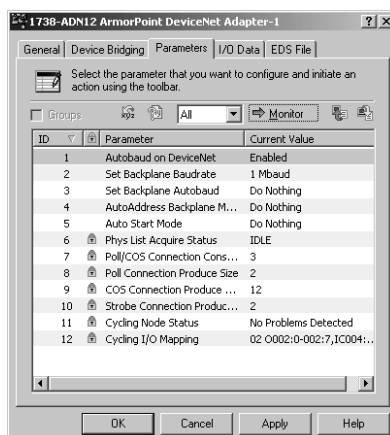

The data format is NN OBBB:b-BBB:b, IDBBB:b-BBB:b, where:

- NN = node number
- O or I = data type (output or input)
- BBB = byte number
- b = bit number
- D = DeviceNet connection (C [COS/cyclic], S [strobe], or P [poll])

IMPORTANT

If an I/O module's data has multiple mappings, you must use RSNetWorx for DeviceNet to browse to the backplane to view the mappings.

Automatic Device Replacement

With Automatic Device Replacement (ADR), the adapter automatically configures a new replacement module.

IMPORTANT

The replacement module must match the original module (i.e., same vendor I.D., device type, product code, major and minor revision) for ADR to work. The parameters that must match are those selected in the electronic keying portion of the scanlist. You determine the level of electronic keying.

The backplane configuration parameters (e.g., Auto Address) should be set to 'Do Nothing'.

The adapter is capable of holding approximately 64K of configuration data for ArmorPoint I/O modules connected to it. The adapter sends configuration data to an I/O module each time connections are created with that module (i.e., power cycle or module insertion to backplane).

You can exchange an old module for a new one if the following conditions are met:

- ADR is enabled in the adapter.
- The new module matches the old one (i.e., electronic keying).
- The new module is inserted in the proper location (only for modules using the backplane).

For modules that do not use the backplane, you can exchange an old module for a new one if the following conditions are met:

- The MACID equals 63.
- The new module matches the electronic keying of the old module.
- Only one missing module matches the electronic keying of the old module.

If the conditions listed above are met, the new module's MACID is changed to the appropriate value, if necessary, and the configuration information is subsequently downloaded to the module.

Physical Ordering

When power is applied, or when an I/O module is inserted, the adapter detects the backplane I/O modules' order, based on MACID. With Physical Ordering, the adapter detects if any ArmorPoint I/O modules connected to it are out of order. If this condition is detected, the adapter changes the MACIDs of any new modules.

IMPORTANT

If any backplane I/O modules are missing when power is applied, none of the backplane modules enter run mode.

The adapter's MACID is always 0 on Subnet. The MACIDs of each attached backplane I/O module must be sequentially ordered (i.e., each module's MACID is greater than the left adjacent module).

Interscan Delay (ISD)

Interscan Delay is the time delay between consecutive I/O scans of polled devices. The default setting is 10ms. The ISD=4ms for Auto Start Mode. You can change this parameter in the **Module** window of the scanner in the RSNetWorx for DeviceNet software.

The scanner uses this period of time to perform non-time-critical communications on the DeviceNet network, such as communicating with RSNetWorx for DeviceNet software. Setting this parameter to a very low value increases the latency for non-time-critical scanner operations, including the time required to respond to RSLinx software and configuration functions. Setting this parameter to a very large value reduces the freshness of the I/O data being collected by the scanner and is not advisable.

Foreground to Background Poll Ratio

Foreground to Background Poll Ratio is the ratio of foreground to background polls. You can set this parameter in the **Module** window of the scanner in RSNetWorx for DeviceNet software.

Devices can be polled on every I/O scan (foreground) or they can be polled less frequently (background). Whether a particular device will be polled in the foreground or in the background is determined by its **Poll Rate** parameter on the **Edit I/O Parameters** dialog box, which is accessed from the **Scanlist** property page.

The poll ratio sets the frequency of poll I/O messages to a device in relation to the number of I/O scans. For example, if the poll ratio is set to 5, the scanner will poll the selected devices once every six I/O scans. We recommend that you use a poll ratio of 1.

Expected Packet Rate

Expected Packet Rate is the rate at which the packets will be expected to be received by the scanner. You set this parameter in the **Module** window (from the **Advanced** button) of the scanner in RSNetWorx for DeviceNet software.

IMPORTANT

We recommend that you do **not** change the Expected Packet Rate unless you are instructed to do so by a Rockwell Automation technical support representative.

Transmit Retries

Transmit Retries are the maximum number of times that the scanner will attempt to send an I/O message to a device before it times out and generates an error message. You set this parameter in the **Module** window (from the **Advanced** button) of the scanner in RSNetWorx for DeviceNet software.

IMPORTANT

We recommend that you do **not** change the Transmit Retries unless you are instructed to do so by a Rockwell Automation technical support representative.

Communicate Through the Adapter

As described previously in this manual, the adapter resides on the DeviceNet network and the PointBus simultaneously. The adapter's functions are as follows:

- DeviceNet – adapter serves as a slave device that exchanges I/O data with another DeviceNet scanner device (e.g., 1771-SDN) via DeviceNet messages
- PointBus – adapter serves as master for up to 63 I/O modules, using DeviceNet messages to consume from or produce data to each module.

IMPORTANT

If Automatic Device Replacement (ADR) is enabled on the adapter, you can only connect up to 62 modules via the PointBus.

For more information on ADR, see page 2-15.

Map the Data

Your adapter must store data temporarily before transferring it between devices. You must map data to your adapter's memory before transferring it.

For a detailed description of the mapping process, see page 2-20.

Overview of the Communication Process

In a typical configuration, the adapter acts as an interface between a DeviceNet scanner (e.g., 1756-DNB) and ArmorPoint I/O modules. The following example graphic shows information transferred from a 1756-DNB to ArmorPoint I/O modules.

IMPORTANT

Although information is exchanged between the Logix5555 and 1756-DNB, this diagram (nor this chapter) is not designed to explain such an exchange.

Four data transfers are shown in the diagram, including:

1. Scanner to adapter
2. Adapter to I/O modules
3. I/O modules to adapter
4. Adapter to scanner

Key Points About Scanner to Adapter Transfer (Step 1)

1. Scanner initiates transfer
2. Scanner uses DeviceNet I/O messaging to write data to adapter. Data may contain:
 - device output data
 - configuration data

Key Points About Adapter to Output Module Transfer (Step 2)

1. Adapter initiates transfer
2. Adapter produces data for I/O module to consume. Data may contain:
 - device output data
 - configuration data

Key Points About Input Module to Adapter Transfer (Step 3)

- Adapter consumes data I/O module has produced. Data may contain:
- device input data
 - status data

Key Points About Adapter to Scanner Transfer (Step 4)

- SDN consumes I/O data produced by adapter. Data may contain:
- device input data
 - status data

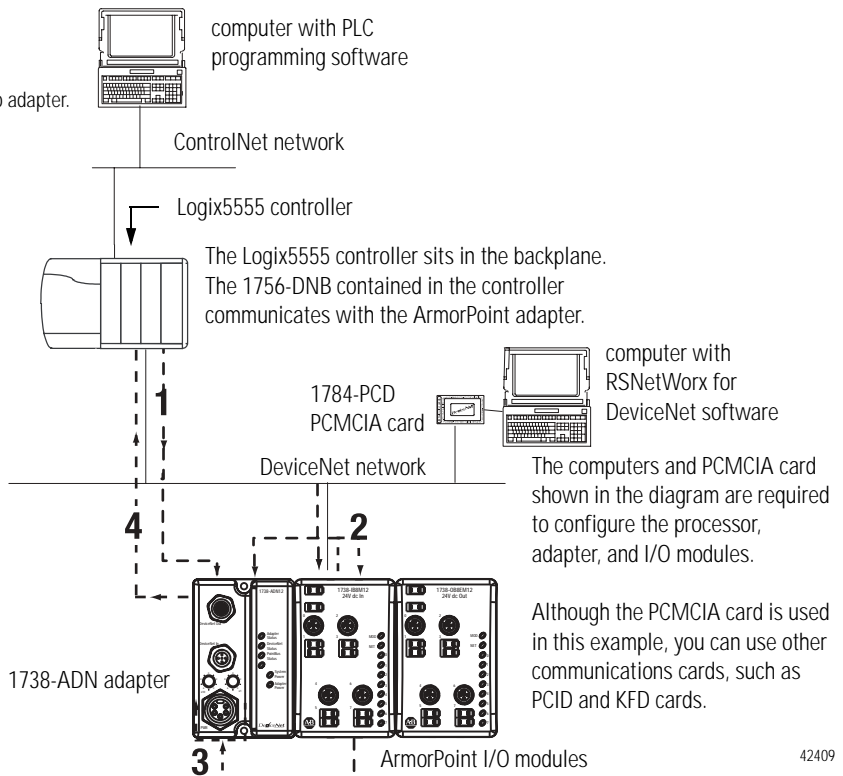

Because the adapter simultaneously resides on the DeviceNet network and on PointBus, it serves as a slave to the processor (i.e., steps 1 and 4) and a master to the I/O modules (i.e., steps 2 and 3).

The four data transfers are not necessarily sequential. Transfers 2 and 3 typically occur more frequently than transfers 1 and 4.

Image Table Mapping

Your adapter receives data from:

- master devices (e.g., scanners) - output data is then passed to ArmorPoint I/O modules
- input modules - input data is passed to the scanner

The adapter must map the data it receives to its internal memory before passing it to the appropriate device. The I/O map for a module is divided into:

- read bytes - input and status bytes
- write bytes - output and configuration bytes

The data is mapped by 3 buffers for input data (each representing an I/O connection on the primary DeviceNet) and 1 buffer for output data (representing data sent for Poll or COS connections on the primary DeviceNet).

The number of read bytes or write bytes can be 2 or more. The length of each I/O module's read bytes and write bytes vary in size depending on module complexity. Each I/O module supports at least 1 input byte or 1 output byte. Status and configuration are optional, depending on the module.

The following graphic shows how the adapter maps information.

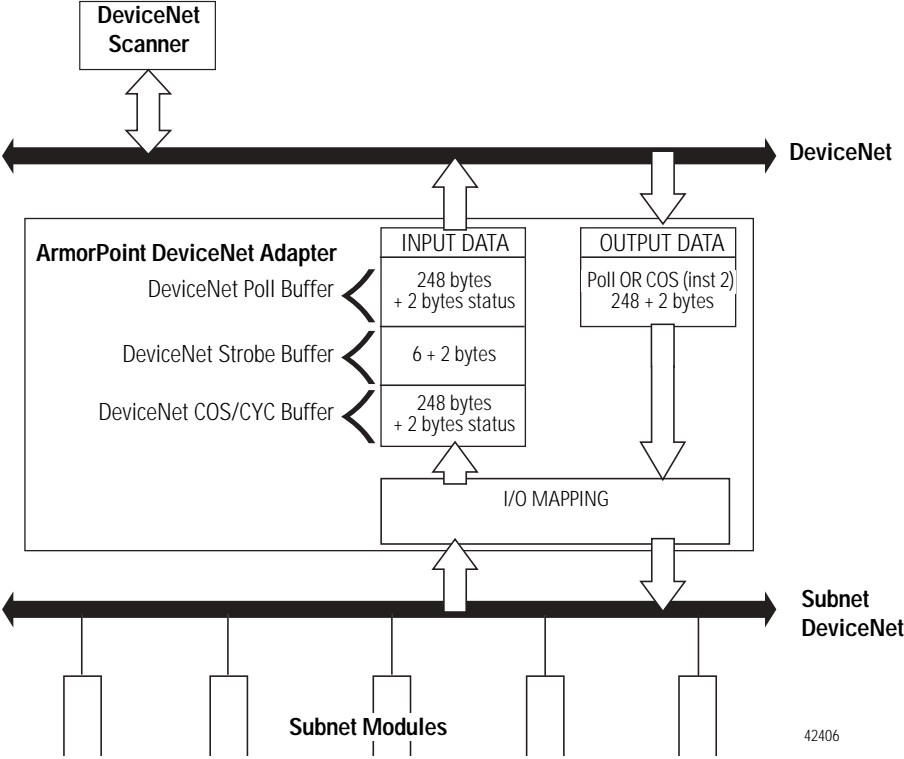

42406

See the I/O Status Word Bit Definitions table for definitions of the first 2 bytes of each I/O message produced by the adapter on DeviceNet.

I/O Status Word Bit Definitions

Bit	Operating Mode	Operating Mode Description
Byte 0	0 = Run mode 1 = Idle mode	Run - The adapter maps output data to each module on PointBus.
	1 = Device failure (at least one device failed)	Idle - Output data with zero length is sent to I/O modules.
	1 = Communication failure	Device Failure - One or more of the devices in the scanlist has failed to communicate with the adapter.
	1 = Duplicate node address failure	
	4	Communications Failure - The adapter has entered the BUSOFF state on the Subnet. Another Subnet device is configured with the wrong baud rate.
	5	
	6	
	7	
Byte 1	0	Duplicate Node Address Failure - There is another node with the same address (0) as the scanner on the Subnet and the adapter has failed its Dup_MAC_ID test.
	1	
	2	
	3	
	4	
	5	
	6	
	7	

The first 2 bytes of output data on the DeviceNet network that are sent to the adapter are reserved as a command word. No bits have been defined.

Communicate With I/O Modules

The adapter module supports multiple communication choices. These choices all use the default I/O structure previously described. The adapter's master (e.g., 1756-DNB) makes the actual communication choice. The choices are:

- Polled – Adapter sends data in response to received data.
- Strobe – Adapter sends data in response to the strobe command. The single bit allocated to the adapter in the strobe message is not used. If the configured size of the input data (sent from the adapter) is greater than 8 bytes, the strobe connection establishment will fail. In this case, the input size must be reconfigured to 8 bytes or less (only 6 bytes are I/O data because the first 2 bytes are the status word).
- Change of State – Adapter sends data based on detection of any changed value within the input data. Data is independently received based on change of state from the sender. Data in both directions can be acknowledged or unacknowledged depending on the run time configuration of the system.
- Cyclic – Adapter sends data cyclically based on a configured time value. Data is independently received cyclically from the sender. Data in both directions can be acknowledged or unacknowledged depending on the run time configuration of the system.

The adapter uses these messages to solicit data from or deliver data to each device. Data received from the devices (i.e., input data) is organized by the adapter and retransmitted to the master. Data received from the master (i.e., output data) is organized in the adapter and sent on to the I/O modules.

Use Diagnostic Tables

The adapter maintains three diagnostic tables to manage the flow of data between a processor and a network's devices. You can access the table over DeviceNet through the Scan Config Object (Class Code 0x90), Instance 1, via the following read-only attributes:

- **Faulted Node Table (Attribute 0xA)** - In this 8-byte table, each bit represents a node on the backplane. For example, bit 0 in byte 0 represents MACID 0 (the adapter), while bit 0 in byte 1 represents MACID 8 and so on. If a bit is set, a corresponding non-zero status value can be read from the Node State Table described below.
- **Idle Node Table (Attribute 0xB)** - In this 8-byte table, each bit also represents a node on the backplane, as with the Faulted Node Table. If a bit is set in the Idle Node Table, the corresponding node is in the scanlist and currently in idle mode.
- **Node Status Table (Attribute 0xC)** - This 64 byte table contains a status code for each possible MACID on the backplane. Non-zero values are accompanied with the respective bit in the Faulted Node Table being set.

See the table Node Status Table Numeric Code Definitions for an explanation of the text messages associated with the Node Status Table.

Node Status Table Numeric Code Definitions

Numeric Code:	Text Message:	Definition:	Take this action:
70	DupMAC Failure	Adapter failed Duplicate Node Address check.	An I/O module has a MACID of zero. Change the module's address.
71	Scanner Cfg Error	Illegal data in the scan list table.	Reconfigure the scan list table and remove any illegal data.
72	Comm Failure	Slave device stopped communicating.	Inspect the I/O modules and verify connections.
73	Wrong Device Type	Device's identity information does not match electronic key in scan list table entry.	Verify that the correct device is at this node number. Make sure that the device matches the desired electronic key (vendor, product code, product type).
74	Port Overrun Error	Data overrun on port detected.	Modify your configuration and check for invalid data. Check network communication traffic.
75	Network Failure	Communication has ceased on the backplane.	Inspect the I/O modules and verify connections.
76	No Msg for Scanner	No direct network traffic for scanner detected.	No action. The scanner hears other network communication.

Node Status Table Numeric Code Definitions

Numeric Code:	Text Message:	Definition:	Take this action:
77	Wrong Data Size	Data size expected by the device does not match scan list entry.	Reconfigure your module for correct transmit and receive data sizes.
78	No Such Device	Slave device in scan list table does not exist.	Add the device to the network, or delete scan list entry for that device.
79	Transmit Failure	Adapter has failed to transmit a message.	Make sure that other modules exist on the backplane.
80	In Idle Mode	Adapter is in IDLE mode.	No action necessary. If you want the adapter to run, put it in RUN mode.
82	Fragmentation Error	Error detected in sequence of fragmented I/O messages from device.	Check scan list table entry for slave device to make sure that input and output data lengths are correct. Check slave device configuration.
83	Slave Init Error	Slave device is returning error responses when scanner attempts to communicate with it.	Check accuracy of scan list table entry. Check slave device configuration. Slave device might be in another master's scan list. Reboot slave device.
84	Not Yet Initialized	Adapter is initializing the DeviceNet channel.	No action.
85	Rcv Buffer Overflow	Data size is larger than 255 bytes.	Configure the device for a smaller data size.
86	Device Went Idle	Device is producing zero length data (idle state) while channel is in Run Mode.	Check device configuration and slave node status.
89	ADR Failed	Failure occurred when downloading ADR data to the I/O module.	Reconfigure the ADR download data for the I/O module.
91	Port Bus Off	Bus-off condition detected on communications port. Scanner is detecting communications errors.	Check DeviceNet connections and physical media integrity. Check system for failed slave devices or other possible sources of network interference.
92	Port Power Off	No network power detected on communications port.	Provide network power. Make sure that scanner drop cable is providing network power to adapter communications port.

A user program can monitor the Device Failure Bit in the I/O message(s) received from the adapter. When it has determined the bit set, you can read the Faulted Node Table and Node Status Table, using the Explicit Message Program Control Feature of the scanner device, to determine the module experiencing problems and the nature of those problems.

Chapter Summary and What's Next

In this chapter you learned about the ArmorPoint DeviceNet adapters. Move to Chapter 3 to learn about using Auto Start Mode.

Use Auto Start Mode

This chapter describes how to use the Auto Start Mode with your ArmorPoint I/O DeviceNet adapters.

See the following sections:	Page:
Why Use Auto Start Mode?	3-2
Install the I/O Module	3-4
Use RSNetWorx for DeviceNet	3-5
Begin Auto Start Mode	3-7
Use Custom Configuration	3-9
Chapter Summary and What's Next	3-10

This chapter assumes you already have an ArmorPoint system mounted. There are five simple steps to the Auto Start Mode:

1. Install the I/O Module

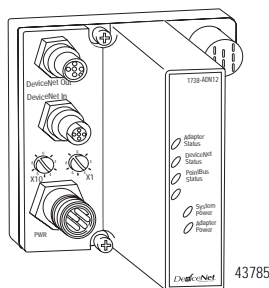

2. Wire the DeviceNet Adapters

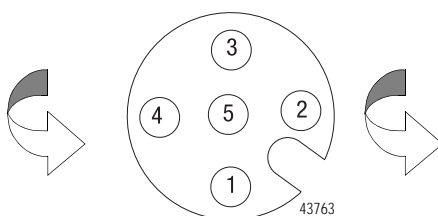

3. Install the I/O Module

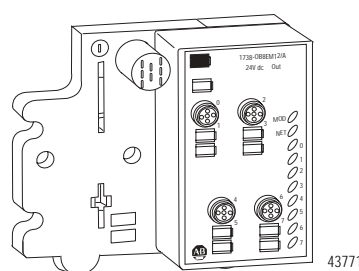

4. 1738-ADNX Only Add and Commission Non-Backplane I/O Modules to the Subnet

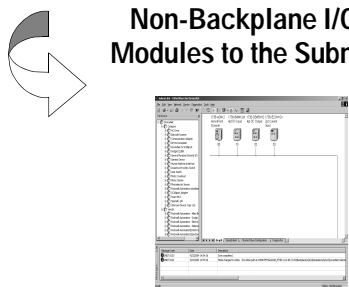

5. Use RSNetWorx for DeviceNet

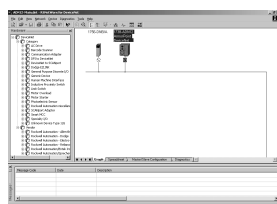

5. Begin Auto Start Mode

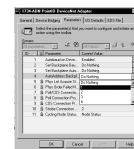

Why Use Auto Start Mode?

Auto Start Mode offers you a quick and easy method of getting your ArmorPoint I/O system 'up and running'. If your ArmorPoint I/O application can use default configuration, you should use Auto Start Mode to easily begin operations.

Once your adapter is:

- installed
- connected to the system's I/O modules
- online (in RSNetWorx for DeviceNet)

you only need to choose the Auto Start Mode option in the adapter's **Parameters** window in the RSNetWorx for DeviceNet software and the adapter begins working with a default configuration.

IMPORTANT

Although Auto Start Mode allows your adapter to operate with a default configuration, you can write a custom configuration after operation has begun.

For more information on how to write custom configuration for your adapter on DeviceNet, see Chapter 5, Add the ArmorPoint DeviceNet Adapter to the DeviceNet Scanner's Scanlist.

What Does Auto Start Mode Do?

When using Auto Start Mode, the adapter:

1. Sets all modules on the backplane to Auto Baud
2. Reads the Subnet module's identity information
3. Sets backplane modules' addresses sequentially
4. Generates a scanlist for the Subnet
5. Maps I/O data, based on byte, word, double-word, or fixed boundaries

When this sequence of events is completed, the ArmorPoint I/O modules connected to the adapter are ready to accept connections from a scanner.

How Is I/O Data Mapped Using Auto Start Mode?

In Auto Start Mode, you can map I/O data in the adapter's memory in one of the following ways:

- Byte Boundaries
- Word Boundaries
- Double Word Boundaries
- Fixed Boundaries

Byte Boundaries

Each node's I/O data is mapped in the adapter's memory at the next available byte. This option works best in applications that use Allen-Bradley PLCs and SLCs.

Word Boundaries

Each node's I/O data is mapped in the adapter's memory at the next available word. This option works best in applications that use Allen-Bradley PLCs and SLCs.

Double Word Boundaries

Each node's I/O data is mapped in the adapter's memory at the next available double word. This option works best in applications that use Allen-Bradley Logix products.

Fixed Boundaries

The map to the fixed location is based on the node address. Mapping size ranges from 1 to 32 and is set using an EDS parameter. The mapping for a node with address 1 begins on byte 2. The formula for mapping is: $2 + ((N-1)(mapsize))$, where N = node address.

Keep the following in mind when using fixed boundaries:

- You specify fixed map size using EDS parameters
- Data is mapped after status/channel words in I/O image, beginning with byte 2
- No data area is reserved for MACID 0 (the adapter)

Requirement To Using Auto Start Mode

Your ArmorPoint DeviceNet adapter must be free of I/O connections on DeviceNet when you use Auto Start Mode. If you attempt to use Auto Start Mode after another scanner device has established I/O connections with the adapter, your attempt to use Auto Start Mode will be rejected. When the adapter is configuring itself in Auto Start Mode, no other device can establish I/O connections to the adapter.

Install the I/O Module

To install the module:

1. Using a bladed screwdriver, rotate the keyswitch on the mounting base clockwise until the correct number for the I/O module aligns with the notch in the base. (See the individual ArmorPoint I/O module installation instructions for this number.)
2. Position the module vertically above the mounting base. The module will bridge two bases.

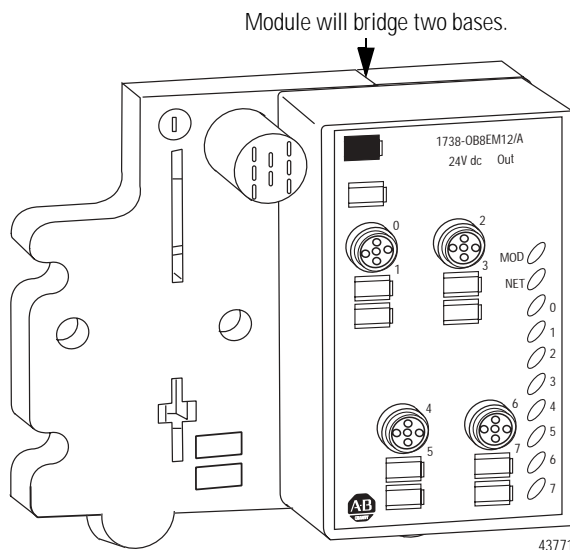

3. Push the module down until it engages the latching mechanism. You will hear a clicking sound when the module is properly engaged.

The locking mechanism will lock the module to the base.

Remove the Module From the Mounting Base

To remove the module from the mounting base:

1. Put a flat blade screwdriver into the slot of the orange latching mechanism.
2. Push the screwdriver toward the I/O module to disengage the latch.

The module will lift up off the base.

3. Pull the module off of the base.

For more information on installing and wiring the multiple ArmorPoint I/O modules, see the installation instructions for each catalog number.

Use RSNetWorx for DeviceNet

You must use the RSNetWorx for DeviceNet software to configure your adapter.

If you are using a 1738-ADNX adapter, make sure that you properly configure non-backplane modules for baudrate and MACID.

Follow the steps below to use Auto Start Mode.

1. Go online in the software.

IMPORTANT

Auto Start Mode is only available when RSNetWorx for DeviceNet is online.

A. Click on the Network pull-down menu.

B. Choose Online.

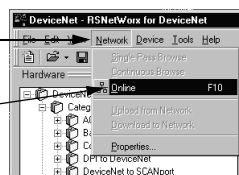

2. Once you are online, browse for the primary network (e.g., You can use Single Pass Browse).

A. Click on the Network pull-down menu.

B. Choose a Browse type.

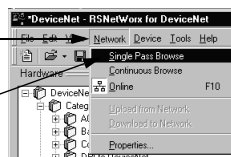

3. Click **OK** to synchronize your offline and online configuration.

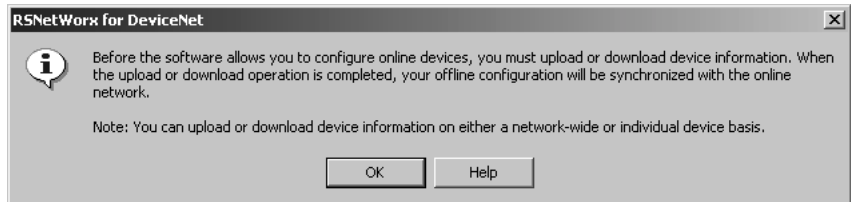

The adapter appears on the screen.

4. Double click on the adapter icon.

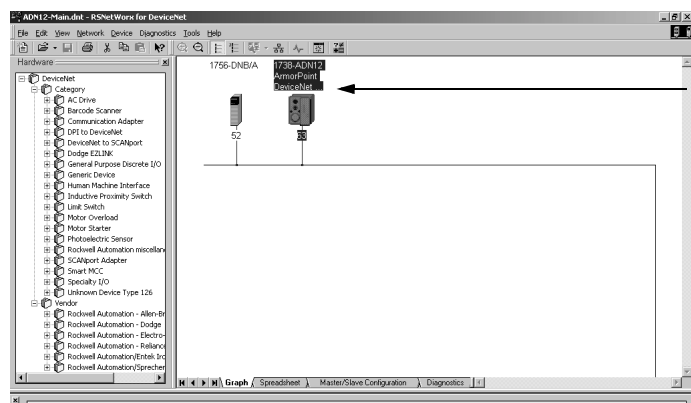

Double click on this icon.

You can either:

- Upload configuration from the device to update the software
- Download configuration from the software to the device

5. Click **Yes** to upload configuration from the device.

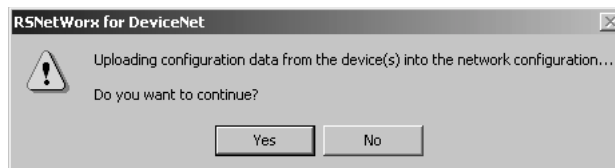

Begin Auto Start Mode

After you upload the configuration from the device to the software, begin Auto Start Mode (ASM).

1. Double click on the adapter icon to open the adapter properties window.
2. Click on the **Parameters** tab.
3. Click on the right side of the Auto Start Mode line so that a menu appears.

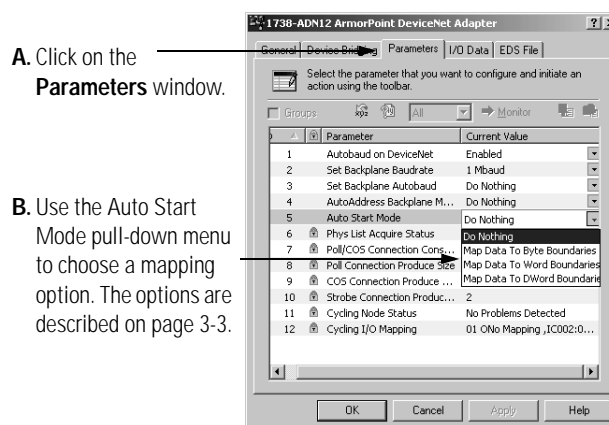

4. Download the Auto Start Mode value. Make sure you only download this single value, as shown below.

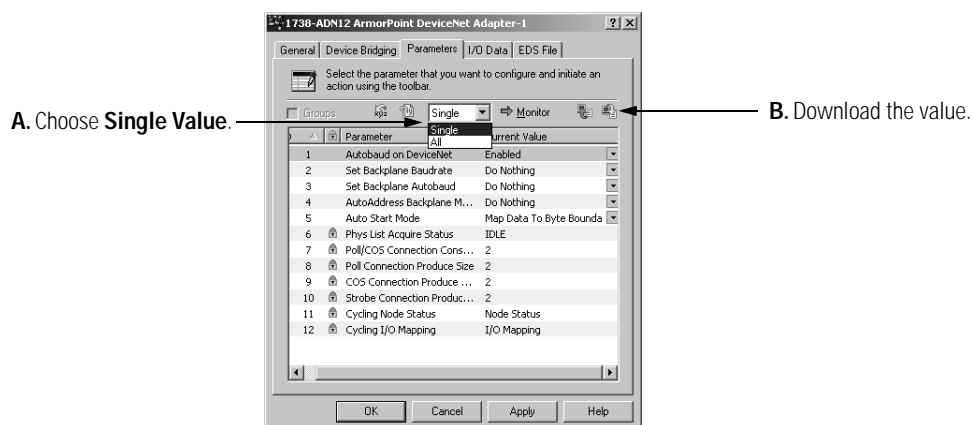

After 30-40 seconds, the adapter begins operations and uses the configuration most recently applied. During the Auto Start Mode process, the **Physical List Acquire Status** field displays the words: **Auto Start Mode**, but after the download is complete the field displays the word **Idle**.

- Check for solid red indicators on all modules
- Verify that all non-backplane modules have the proper baudrate (or have autobaud enabled)

- Check that MACIDs are set to proper values
- Check scanlist
 - browse to Subnet and view scanlist, or look at mapping text
 - Make sure the scanlist was saved (if not, investigate why?)
 - If you are using the 1738-ADNX adapter, check the **Max(imum) Backplane MACID** parameter. It should equal the number of modules residing on the backplane.

After ASM has completed (that is, **Physical List Acquire Status** field is **Idle**), verify that the operation was successful and that each I/O module was added to the adapter's scanlist. The PointBus Status LED should be solid green. This indicates only that the adapter is able to establish I/O connections with each module in its scanlist, not that each module on the Subnet was successfully added to its scanlist.

To verify the presence of each module in the adapter's scanlist, perform one of the following checks:

- Each I/O module's NET LED should be solid green. If the device has neither LED, use one of the following methods.
 - By browsing to the Subnet and uploading the adapter's scanlist using RSNetWorx for DeviceNet and verifying that the device is found in the scanlist.
 - By repeatedly uploading the EDS parameter **Cycling I/O Mapping** to verify that a mapping for the concerned module exists. See page 2-15 for more information about this parameter.

If one of the following is observed, it is likely that one of the Subnet modules has been addressed incorrectly or is configured to communicate at the wrong baud rate.

- The adapter's PointBus Status LED is solid or blinking red
- An I/O module's NET LED is solid red
- It appears that the adapter has not saved a scanlist

Use the following procedures to attempt to remedy a problem:

- Verify that each non-backplane module's address and baudrate have been set correctly.
- Verify that each backplane module is configured to autobaud. The adapter's EDS parameter **Set Backplane Autobaud** can be used to set each module's autobaud parameter. It is necessary to cycle a module's power before the autobaud parameter change takes effect. In rare situations, it may be necessary to download the parameter and cycle power several times before each backplane module's autobaud parameter has been changed.

Note that if the adapter is configured to autobaud on the primary DeviceNet network, network traffic on the primary network is required before the backplane modules will attempt to communicate. For this reason, it is sometimes helpful to have RSLinx continuously browsing the primary network while attempting the ASM process and verification.

When it is believed that each non-backplane module is correctly configured and that each backplane module is able to communicate on the Subnet, the ASM process can be attempted again.

After successfully configuring your adapter with the Auto Start Mode feature, the adapter must still be added to the primary DeviceNet network scanner's scanlist. See Chapter 5 for more information.

Use Custom Configuration

The Auto Start Mode is recommended to quickly and easily get your ArmorPoint I/O system 'up and running'. But this mode does not prevent you from changing the adapter's default configuration after system operation has begun.

For more information on how to write custom configuration for your adapter on DeviceNet, see Chapter 4, Configure the DeviceNet Scanner Subnet and Chapter 5, Add the ArmorPoint DeviceNet Adapter to the DeviceNet Scanner's Scanlist.

IMPORTANT

The adapter's ADR configuration for the Subnet modules is reset when you run Auto Start Mode.

Chapter Summary and What's Next

Auto Start Mode was discussed in this chapter. Move on to Chapter 4, Configure the DeviceNet Scanner Subnet or to Chapter 5, Add the ArmorPoint DeviceNet Adapter to the DeviceNet Scanner's Scanlist.

Configure the DeviceNet Scanner Subnet

This chapter describes how to custom configure your scanner for use with ArmorPoint I/O modules.

See the following sections:	Page:
Configuration Overview	4-1
Add the Scanner To Your Network	4-2
Add I/O Modules To Your Network	4-3
Set the Scanner's Parameters	4-3
Go On Line	4-8
Chapter Summary and What's Next	4-8

Your adapter works on two networks simultaneously and must be configured for each separately. This chapter explains configuration of the scanner for use with ArmorPoint I/O modules.

For information on how to configure the adapter for use on the DeviceNet Network see Chapter 5, Adding the DeviceNet adapters to the DeviceNet Scanner's Scanlist.

Configuration Overview

You must use the RSNetWorx for DeviceNet software to configure your scanner. You can configure the scanner while it is:

- on line
- off line

This chapter shows configuration in the offline mode. Configuration screens appear the same in both modes. Note that some screen options are unavailable in offline mode. The only difference is that if you make changes off line, you must take the scanner on line before the configuration changes take effect.

IMPORTANT

Throughout most of this manual, we refer to the ArmorPoint I/O DeviceNet adapter as the adapter. The adapter also communicates with Subnet modules as a scanner. In this chapter only, the adapter is referred to as a scanner.

You must follow these steps during configuration:

1. Add the scanner to your network
2. Add I/O modules to your network
3. Set the scanner's parameters
4. Go on line

Add the Scanner To Your Network

Follow these steps:

1. Start RSNetWorx for DeviceNet.
2. Add the scanner as shown below.

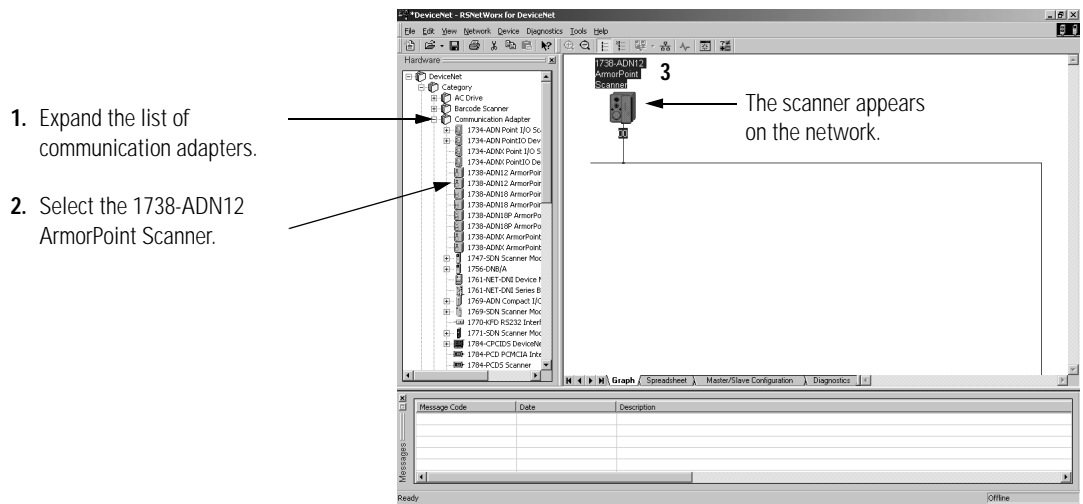

IMPORTANT

The scanner must always exist on the Subnet at Node 00.

Add I/O Modules To Your Network

After you add the scanner, you must add the modules connected to the scanner on the Subnet. In the offline mode, I/O modules must be added individually. Follow these steps:

1. Add modules as shown below.

1. Expand the **Category** to display the list of I/O modules.

NOTE: Make sure you check under all the categories that I/O modules reside (i.e., **General Purpose Discrete I/O**, **Rockwell Automation miscellaneous**, and **Specialty I/O**).

2. Double-click the I/O module you want to add to the network.

TIP: You can also click and drag the module name onto the network.

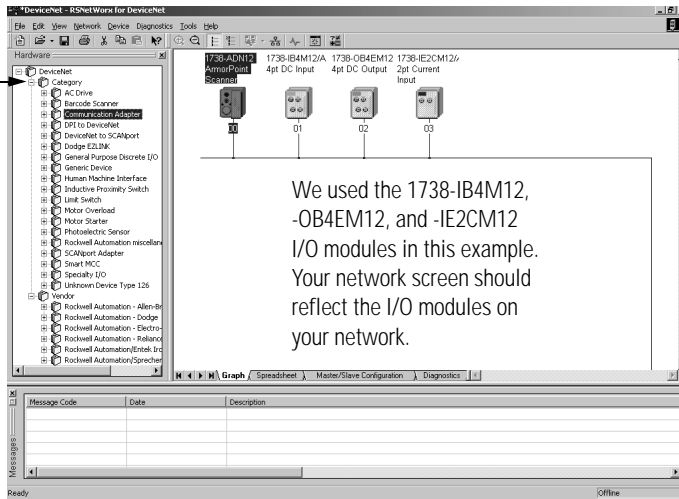

Set the Scanner's Parameters

After adding the scanner to the network, you must configure it for use with I/O modules.

IMPORTANT

This chapter shows configuration in the off line mode. Changes set in this mode do not take effect until the scanner goes on line. For more information on how to go on line, see page 4-8.

1. Configure the scanner as shown below.

1. Right-click on the scanner.

2. Click on **Properties...** to configure your scanner.

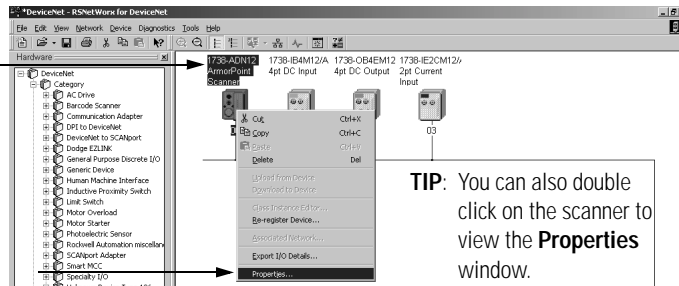

A window will open with a series of tabs along the top. Each tab opens to a window that provides options to write configuration for your scanner. These windows are shown on the following pages.

General window

Type the scanner's name here. →

Type a description here (optional). →

The scanner's address must = 0. →

This window also shows the scanner's device identity. These fields are read-only. →

Click **OK** to accept the parameters.

IMPORTANT: Configuration changes made in offline mode do not take effect until the scanner goes on line. For more information on how the scanner goes on line, see page 4-8.

Device Bridging window

Use **Associate File** to associate this configuration file with the configuration file that configures the same 1738 ArmorPoint DeviceNet scanner (called adapter on the primary network) for communication with a master device on the primary DeviceNet network. →

Use **Clear Association** to remove previously established configuration file associations that no longer apply to your scanner. →

For more information on the need to maintain two configuration files in the same adapter and the simultaneous presence of the adapter on two networks (i.e., DeviceNet as a slave and PointBus as a master), see page 4-1.

Module window

Set the **Interscan Delay** here.

Set the **Foreground to Background Poll Ratio** here.

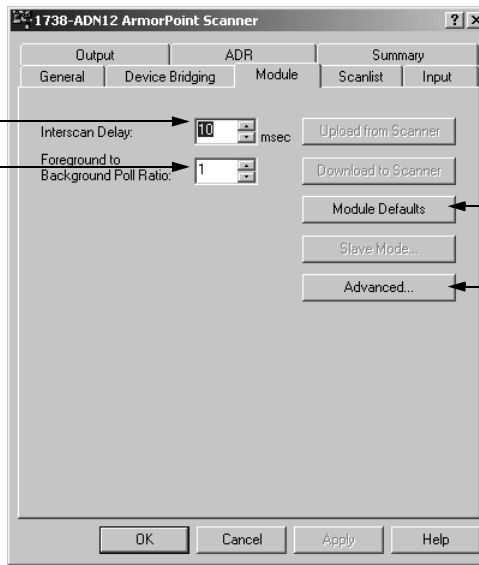

Click here to reset the **Interscan Delay** and **Foreground to Background Poll Ratio** back to the module default values.

Click **Advanced** to change the advanced module settings, as shown in the following window.



Advanced window accessed from **Module** window

We recommend you **DO NOT** change module settings unless advised to do so by a Rockwell Automation support representative.

Set the **Expected Packet Rate** here.

Set the number of **Transmit Retries** here.

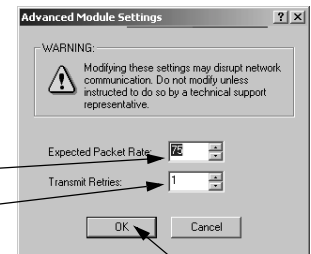

Click **OK** to accept new settings.

Scanlist window

Add and remove I/O modules to and from the scanlist on this screen.

To set any of the parameters on this screen (e.g., **Node Active**) for a specific module, first add the module to the scanlist and then highlight the module to make specific changes.

Click **Automap on Add** so a checkmark appears to automap I/O data when adding modules.

Click **Edit I/O Parameters** to edit the module's I/O parameters, as shown below.

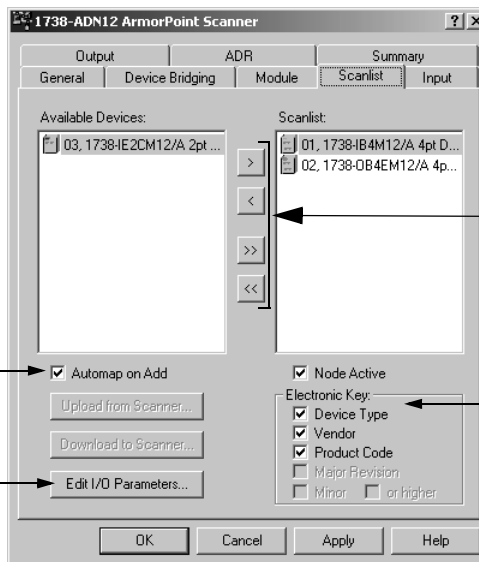

Add modules to or remove modules from the scanlist.

Choose **Electronic Key** parameters for each module.

Edit I/O Parameters window accessed from **Scanlist** window

Click **OK** when finished.

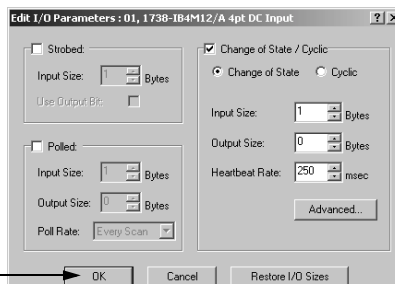

Click on the appropriate I/O data transmission method (e.g., Polled) and make other appropriate I/O parameter changes on this screen.

Input window

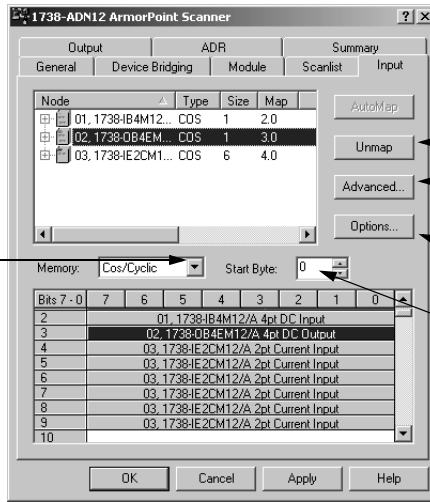

Use this pull-down menu to choose a **Memory** type.

The memory type corresponds to an I/O connections on DeviceNet.

Highlight a module and click **Unmap** to unmap it.

Click **Advanced** to edit the advanced mapping parameters, as shown below.

Click **Options** to edit the automap options, as shown below.

Set the starting byte for I/O mapping.

Advanced Mapping window accessed from Input window

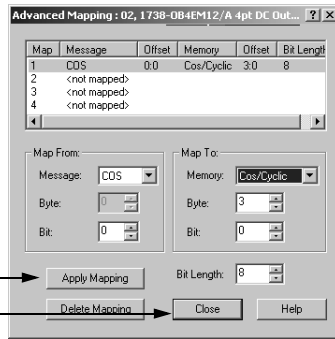

Set **Map From** parameters here.

Click **Apply Mapping** to apply changes and leave the screen open.

Click **Close** when finished.

Set **Map To** parameters here.

Automap Options window accessed from Input window

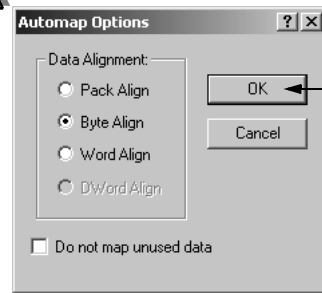

Choose a **Data Alignment** and click **OK**.

Output window

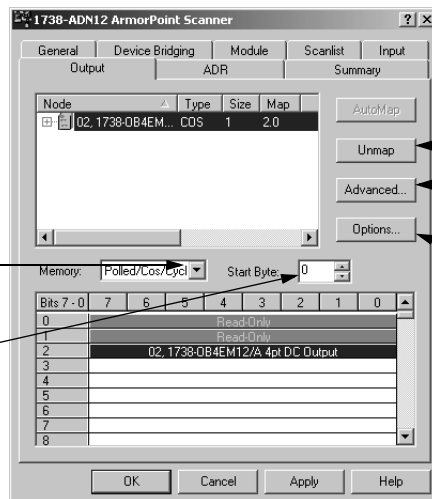

Use this pull-down menu to choose a memory type. This corresponds to I/O on the primary DeviceNet.

Set the starting byte for I/O mapping here.

The bytes mapped last will determine sizes on the primary DeviceNet.

Highlight a module and click **Unmap** to unmap it.

Click **Advanced** to edit the advanced mapping parameters.

Click **Options** to edit the automap options.

Note that the **Advanced Mapping** and **Options** windows are the same for output modules as those shown for input modules. See above for an explanation of these windows.

Following are the remaining configuration windows.

ADR window

Use this screen to choose Automatic Device Replacement options.

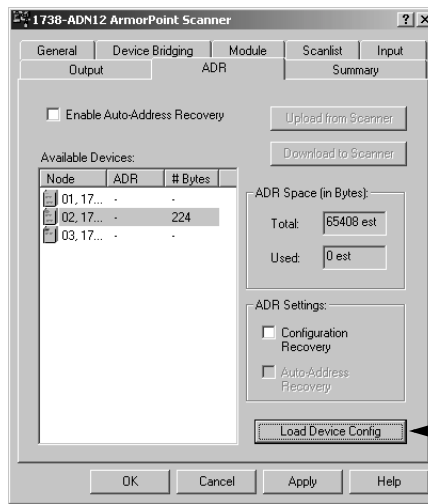

You must have loaded each device into RSNetWorx for DeviceNet before you can **Load Device Config** using this button.

Summary window

IMPORTANT: You cannot change any configuration parameters on this screen. It is for information purposes only. These buttons do not apply for this window but are here to maintain consistency among the windows.

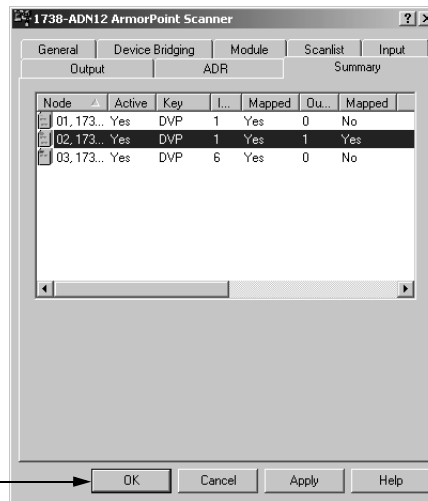

This completes the configuration options. Your scanner must go on line for configuration changes to take effect.

Go On Line

After you set configuration parameters, your scanner must go on line to accept the configuration changes. Follow these steps:

1. Use the Network pulldown to go on line.

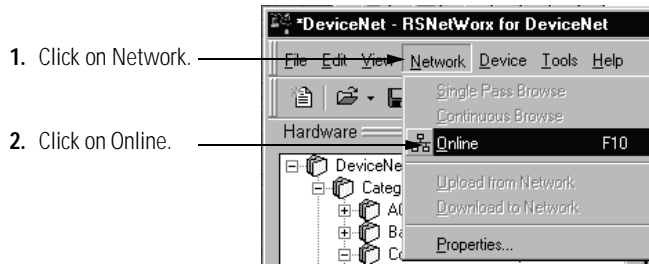

The software prompts you to save your configuration changes.

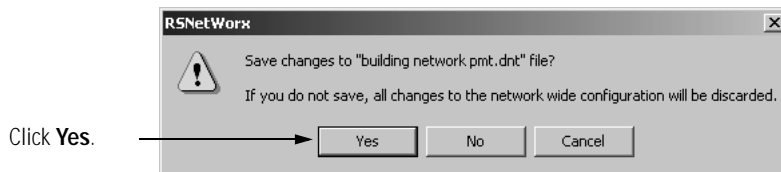

2. Choose your scanner's network and apply the changes, as shown below.

Select the DeviceNet network subnetwork.

This selection accesses the PointBus to configure the adapter on the DeviceNet network.

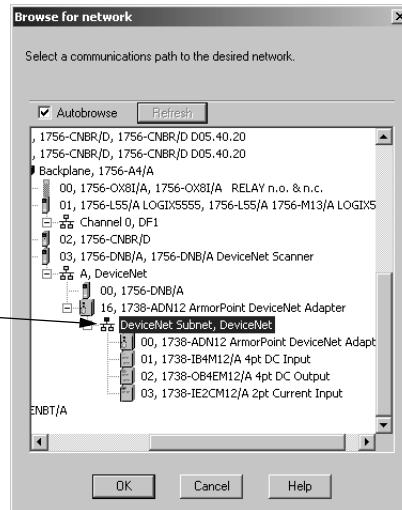

Click **OK** to apply the data to your scanner.

Chapter Summary and What's Next

In this chapter, you learned how to configure the scanner. Move to Chapter 5 to learn how to add the ArmorPoint DeviceNet adapter to the DeviceNet scanner's scanlist.

Add the ArmorPoint DeviceNet Adapter to the DeviceNet Scanner's Scanlist

This chapter describes how to custom configure your adapter for use with DeviceNet devices.

See the following sections:	Page:
Configuration Overview	5-1
Add the Adapter to Your Network	5-2
Set the Adapter's Parameters	5-3
Go On Line	5-6
Chapter Summary	5-6

Your adapter works on two networks simultaneously and must be configured for each separately, which means that you will have two separate RSNetWorx for DeviceNet software files.

This chapter explains configuration of the adapter for use on the primary DeviceNet network. For information on how to configure the adapter for use on the Subnet, see Chapter 4, Configure the DeviceNet Scanner Subnet.

Configuration Overview

You must use the RSNetWorx for DeviceNet software to configure your adapter. You can configure the adapter while it is:

- on line
- off line

This chapter shows configuration in the offline mode. Configuration screens appear the same in both modes. Note that some screen options are unavailable in offline mode. The only difference is that if you make changes off line, you must take the adapter on line before the configuration changes take effect.

You must follow these steps during configuration:

1. Add the adapter to your network
2. Set the adapter's parameters
3. Add the DeviceNet adapter's scanlist (see the Quick Start, Appendix B)
4. Go on line

Add the Adapter to Your Network

Follow these steps:

1. Start the RSNetWorx for DeviceNet software.
2. Add the adapter as shown below.

1. Expand the list of communication adapters.
2. To add the adapter, you can double click on the adapter or click and drag the adapter name onto the network.

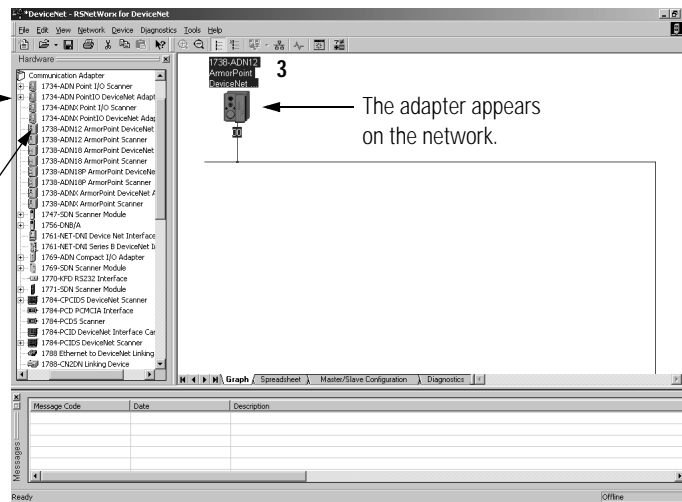

Set the Adapter's Parameters

After adding the adapter to the network, you must configure it for use with master DeviceNet devices.

IMPORTANT

This chapter shows configuration in the offline mode. Changes set in this mode do not take effect immediately. For configuration changes to take place, you must:

- go on line with your adapter
- download the new configuration to your adapter

For more information on how to go on line, see page 5-6.

1. Configure the adapter as shown below.

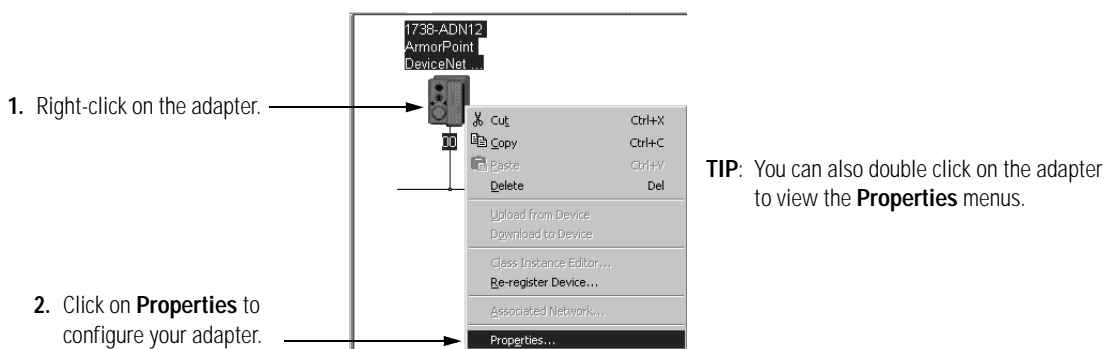

You see a window with a series of tabs. Each tab opens to a window that provides options to write configuration for your adapter. The tabs are shown on the following pages.

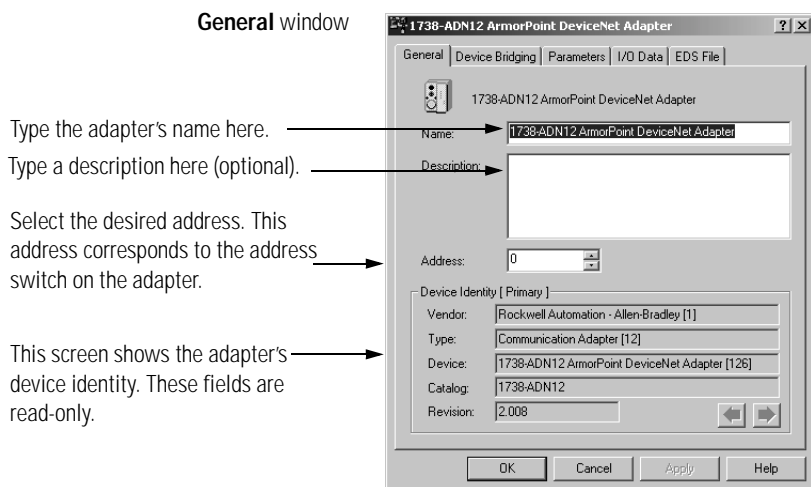

Device Bridging window

Use **Associate File** to associate this configuration file with the configuration file that configures the same ArmorPoint DeviceNet scanner for communication with ArmorPoint I/O modules.

For more information on the need to maintain two configuration files in the same adapter and the simultaneous presence of the adapter on two networks (i.e., DeviceNet as a slave and Subnet as a master), see page 5-1.

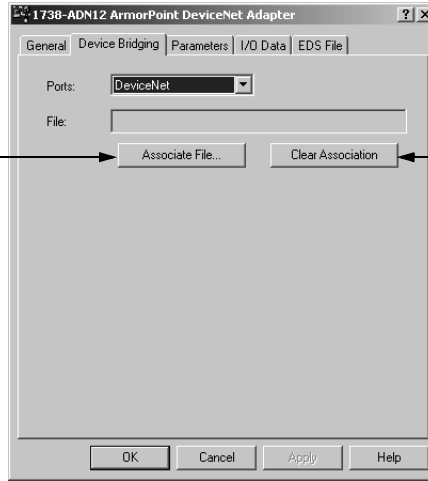

Use **Clear Association** to remove previously established configuration file associations that no longer apply to your adapter.

Parameters window

Restore all parameter default values.
For a description of a specific parameter, highlight the parameter below and click here.

Any parameter with a lock shown before it cannot be changed.

The values correspond to the I/O connection sizes from the **I/O Data** window. They can be uploaded from an adapter with a downloaded scanlist.

The following screens show how to change the other parameters.

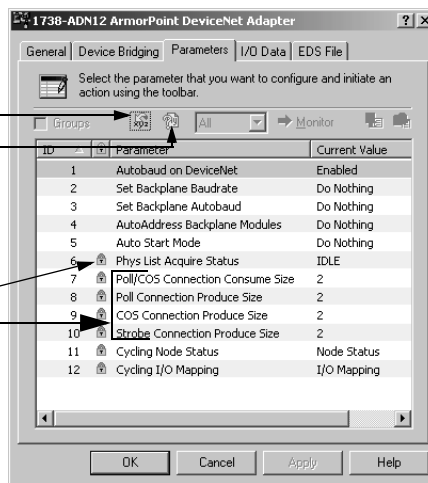

IMPORTANT: The following configuration parameters:

- **Auto Start Mode**
- **Set Backplane Baudrate**
- **Set Backplane Autobaud**
- **AutoAddress Backplane Modules**

should only be used when on line and should be set to **Do Nothing** when **Download All Parameters** is selected or when saving to a scanner's ADR data.

Note:

The parameters **Max Backplane MACID** and **Fixed Map Size** are found only in the 1738-ADNX **Parameters** window.

AutoAddress

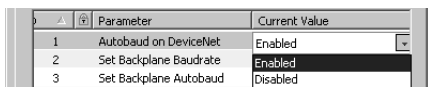

Enable or disable autoaddress.

Backplane Autobaud

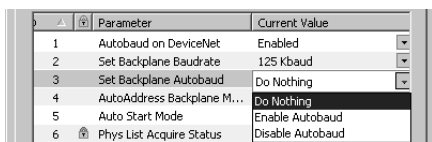

Configure backplane modules to autobaud.

Auto Start Mode

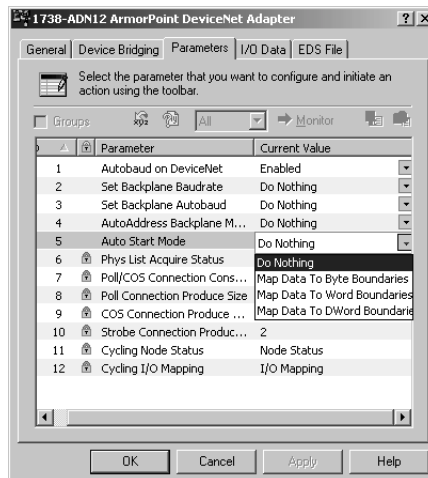

Backplane Baudrate

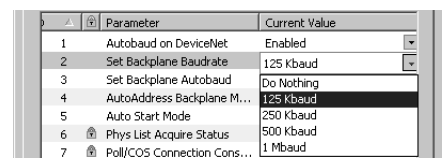

Set the backplane baudrate.

AutoAddress Backplane Modules

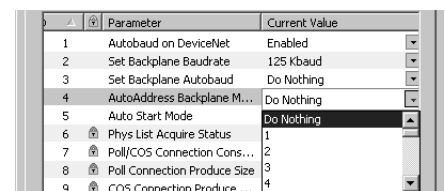

Choose the autoaddress.

The following screens show the remaining configuration windows.

I/O Data window

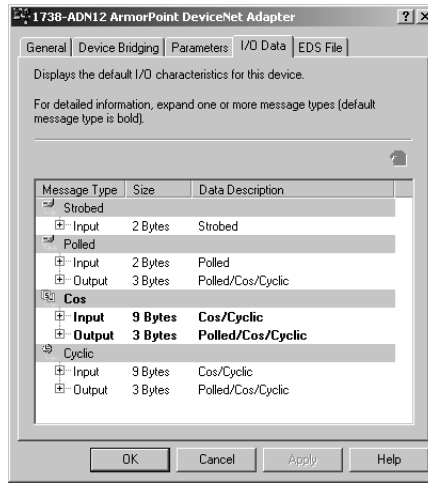

Connection sizes appear only when the Subnet network file has been associated in the **Device Bridging** window.

These values correspond to the 4 parameters (**Poll/COS Connection Consume Size, Poll Connection Produce Size, COS Connection Produce Size, Strobe Connection Produce Size**) found in the device's **Parameters** window.

EDS File window

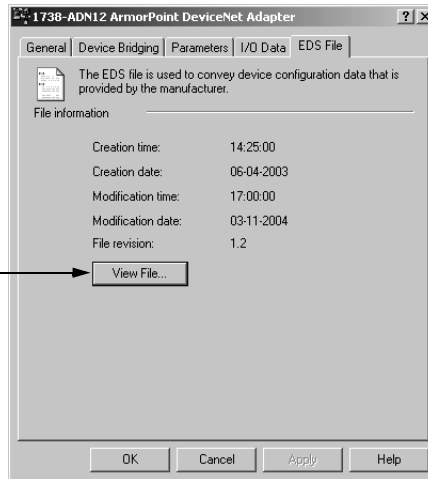

Click here to view the EDS file. An example of the EDS file is shown below.



The window below shows an example EDS file.

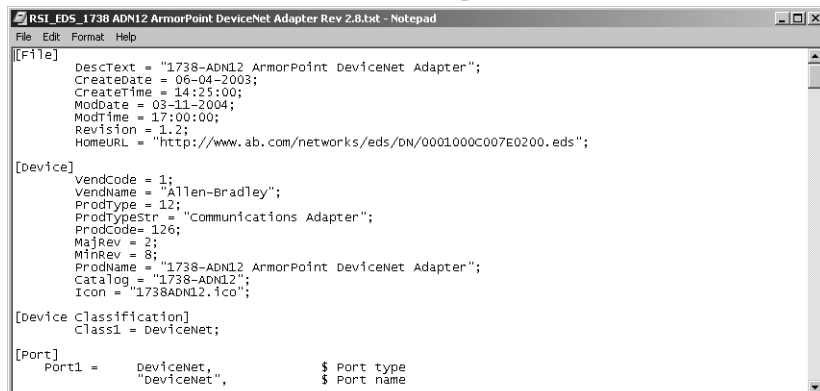

This completes the configuration options. Your adapter must go on line for the configuration to take effect.

Go On Line

Follow these steps for the adapter to go on line:

1. Use the **Network** pulldown.

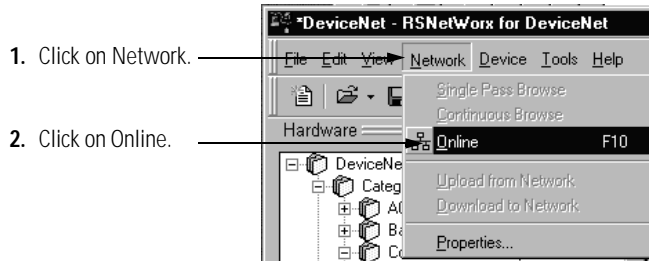

The software prompts you to save your configuration changes.

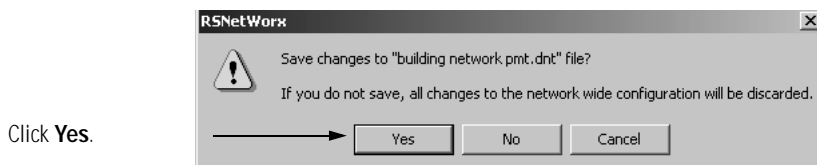

2. Choose your adapter's network as shown below.

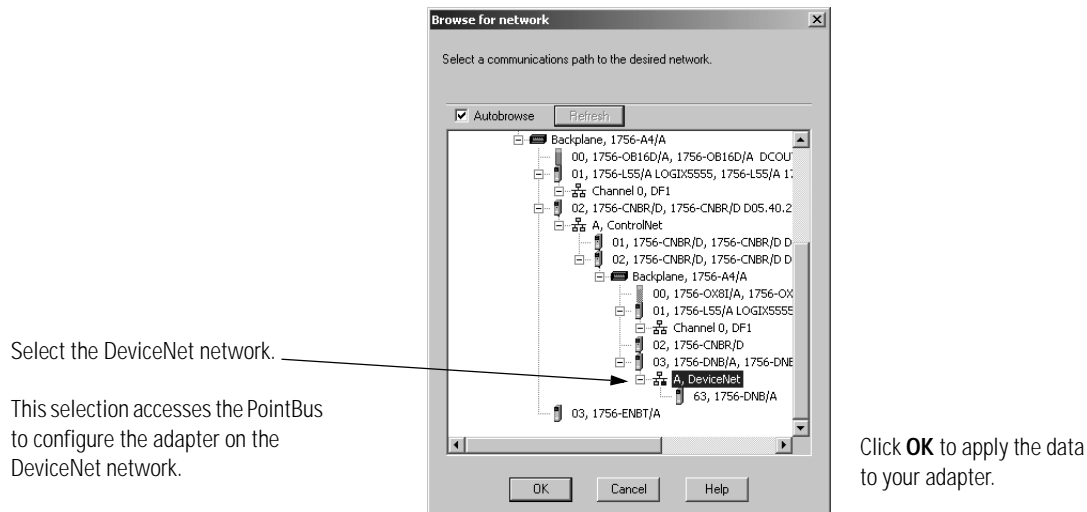

To learn how to add the ArmorPoint DeviceNet adapter to the scanner's scanlist, refer to the Quick Start section, Appendix B.

Chapter Summary

In this chapter, you learned how to configure the adapter.

Troubleshoot the ArmorPoint DeviceNet Adapter

This chapter describes how to troubleshoot your adapter.

See the following sections:	See page:
Use the Status Indicators	6-1
Guidelines for Using Your Adapter	6-3
Chapter Summary	6-3

Use the Status Indicators

You can use the status indicators to troubleshoot your adapter. The following graphic shows the adapter's status indicators.

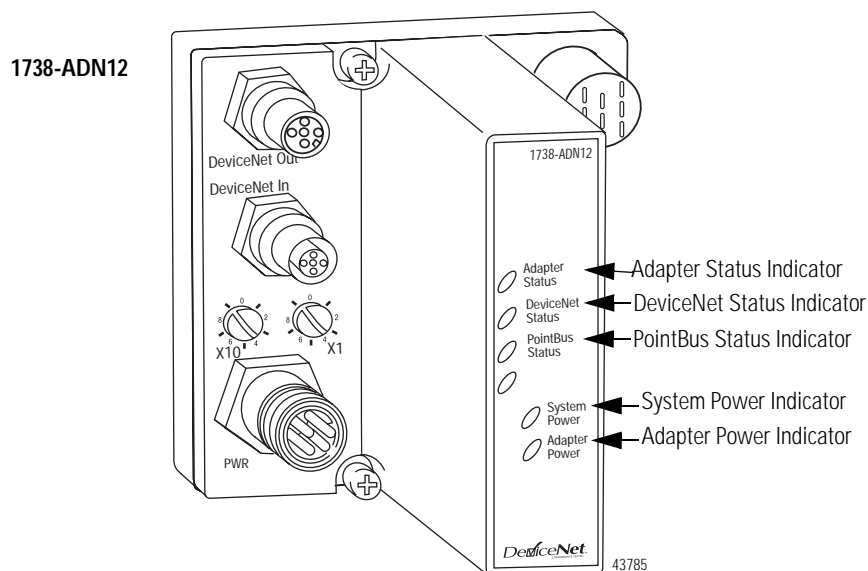

Use the table below to troubleshoot your adapter

Indication	Indication	Probable Cause
Adapter Status	Off	No power applied to device.
	Green	Device is operating normally.
	Flashing Red	Recoverable fault.
	Red	Unrecoverable fault - may require device replacement.
	Flashing Red/Green	Device is in self-test.

Indication	Indication	Probable Cause
DeviceNet Status	Off	Device is not on line: - Device attempting to AutoBaud - Device has not completed dup_MAC_ID test - Device not powered - check module status indicator.
	Flashing Green	Device is on line but has no connections in the established state.
	Green	Device is on line and has connections in the established state.
	Flashing Red	One or more I/O connection in timed-out state.
	Red	Critical link failure - failed communication device. Device detected error that prevents it from communicating on the network. (Possible duplicate MACID or baud rate mismatch).
PointBus Status	Off	Device is not on line: - Device has not completed dup_MAC_ID test - Device not powered - check module status indicator.
	Flashing Green	Device is on line but has no connections in the established state.
	Green	Device is on line and has connections in the established state.
	Flashing Red	One or more I/O connection in timed-out state.
	Red	Critical link failure - failed communication device. Device detected error that prevents it from communicating on the network. (Possible duplicate MACID or baud rate mismatch).
	Flashing Red/Green	Communication faulted device - the device has detected a network access error and is in communication faulted state. Device has received and accepted an Identify Communication Faulted Request - long protocol message.
PointBus Status (1738-ADNX only)	Off	No power applied to device. Device not on line Device has not completed dup_MAC_ID test.
	Green	Subnet on line and has connections in the established state.
	Flashing Red	Recoverable fault: - No scanlist configured - Problem with module in scanlist (missing, mismatch, etc.).
	Red	Unrecoverable fault may require device replacement (Possible duplicate MACID or baud rate mismatch.)
System Power	Off	Not active - Field power is off or dc-dc-converter problem.
	Green	System power on - dc-dc converter active (5V).
Adapter Power	Off	Not active - Field power is off.
	Green	Power on, 24V present.

Guidelines for Using Your Adapter

Remember the following operational guidelines when using your ArmorPoint DeviceNet adapter.

- Do not leave spaces in the I/O. Instead, install all ArmorPoint I/O modules adjacent to each other.
- Populate every position on the mounting base.
- Do not add new I/O modules to the end of the ArmorPoint I/O system while the system is under power.
- Use labels with the I/O modules.
- Do not move I/O modules to different locations on the mounting base after they have been installed and configured.
- If adjacent modules (i.e., 2 or more) are removed, replace all of them to operate the ArmorPoint I/O system. Input data will hold last state until all previously removed modules are replaced.
- Use Allen-Bradley marker cards to identify your ArmorPoint I/O modules. The cards are easily ordered from your Rockwell Automation representative under the Bulletin 1492 number.
- Properly terminate the 1738-ADNX Subnet at the ends of the Subnet trunk line.
- Correctly set the Max Backplane MACID (1738-ADNX only).

Chapter Summary

In this chapter you learned how to troubleshoot your adapter.

Notes:

Specifications

Following are specifications for the 1738 ArmorPoint DeviceNet adapters.

ArmorPoint DeviceNet Adapters - 1738-ADN12, -ADN18, -ADN18P, and -ADNX

Expansion I/O Capacity	<ul style="list-style-type: none"> • DeviceNet adapter backplane current output = 1.0 A maximum. See the following list for backplane current consumption for each ArmorPoint I/O catalog number and the current consumption for each of the ArmorPoint modules connected to the ArmorPoint DeviceNet adapter. Verify that it is below 1.0 A. • Backplane current can be extended beyond 1.0 A with a 1738-EP24DC Backplane Extension Power Supply. The 1738-EP24DC can supply up to an additional 1.3 A of backplane current. • Multiple 1738-EP24DC modules can be used to reach the maximum of 63 modules. <table border="1" data-bbox="695 926 1318 1724"> <thead> <tr> <th>Cat. No.</th> <th>PointBus Current Requirements</th> </tr> </thead> <tbody> <tr><td>1738-IB2M12</td><td>75mA</td></tr> <tr><td>1738-IB4xxx</td><td>75mA</td></tr> <tr><td>1738-IB8xxx</td><td>75mA</td></tr> <tr><td>1738-IV4xxx</td><td>75mA</td></tr> <tr><td>1738-IV8xxx</td><td>75mA</td></tr> <tr><td>1738-OB2EM12</td><td>75mA</td></tr> <tr><td>1738-OB2EPM12</td><td>75mA</td></tr> <tr><td>1738-OB4Exxx</td><td>75mA</td></tr> <tr><td>1738-OB8Exxx</td><td>75mA</td></tr> <tr><td>1738-OV4EM12</td><td>75mA</td></tr> <tr><td>1738-OW4xxx</td><td>90mA</td></tr> <tr><td>1738-IE2CM12</td><td>75mA</td></tr> <tr><td>1738-OE2CM12</td><td>75mA</td></tr> <tr><td>1738-IE2VM12</td><td>75mA</td></tr> <tr><td>1738-OE2VM12</td><td>75mA</td></tr> <tr><td>1738-IA2xxx</td><td>75mA</td></tr> <tr><td>1738-OA2xxx</td><td>75mA</td></tr> <tr><td>1738-IJM23</td><td>160mA</td></tr> <tr><td>1738-SSIM23</td><td>110mA</td></tr> <tr><td>1738-IR2M12</td><td>220mA</td></tr> <tr><td>1738-IT2IM12</td><td>175mA</td></tr> <tr><td>1738-VHSC24M23</td><td>180mA</td></tr> <tr><td>1738-232ASCM12</td><td>75mA</td></tr> <tr><td>1738-485ASCM12</td><td>75mA</td></tr> </tbody> </table>	Cat. No.	PointBus Current Requirements	1738-IB2M12	75mA	1738-IB4xxx	75mA	1738-IB8xxx	75mA	1738-IV4xxx	75mA	1738-IV8xxx	75mA	1738-OB2EM12	75mA	1738-OB2EPM12	75mA	1738-OB4Exxx	75mA	1738-OB8Exxx	75mA	1738-OV4EM12	75mA	1738-OW4xxx	90mA	1738-IE2CM12	75mA	1738-OE2CM12	75mA	1738-IE2VM12	75mA	1738-OE2VM12	75mA	1738-IA2xxx	75mA	1738-OA2xxx	75mA	1738-IJM23	160mA	1738-SSIM23	110mA	1738-IR2M12	220mA	1738-IT2IM12	175mA	1738-VHSC24M23	180mA	1738-232ASCM12	75mA	1738-485ASCM12	75mA
Cat. No.	PointBus Current Requirements																																																		
1738-IB2M12	75mA																																																		
1738-IB4xxx	75mA																																																		
1738-IB8xxx	75mA																																																		
1738-IV4xxx	75mA																																																		
1738-IV8xxx	75mA																																																		
1738-OB2EM12	75mA																																																		
1738-OB2EPM12	75mA																																																		
1738-OB4Exxx	75mA																																																		
1738-OB8Exxx	75mA																																																		
1738-OV4EM12	75mA																																																		
1738-OW4xxx	90mA																																																		
1738-IE2CM12	75mA																																																		
1738-OE2CM12	75mA																																																		
1738-IE2VM12	75mA																																																		
1738-OE2VM12	75mA																																																		
1738-IA2xxx	75mA																																																		
1738-OA2xxx	75mA																																																		
1738-IJM23	160mA																																																		
1738-SSIM23	110mA																																																		
1738-IR2M12	220mA																																																		
1738-IT2IM12	175mA																																																		
1738-VHSC24M23	180mA																																																		
1738-232ASCM12	75mA																																																		
1738-485ASCM12	75mA																																																		
DeviceNet Communication Rate	125K bit/s (500m maximum) 250K bit/s (250m maximum) 500K bit/s (100m maximum)																																																		
DeviceNet Cable	Refer to publication M115-CA001 for more information																																																		

ArmorPoint DeviceNet Adapters - 1738-ADN12, -ADN18, -ADN18P, and -ADNX

DeviceNet Power Specifications

Power Supply	Note: In order to comply with CE Low Voltage Directives (LVD), you must use either a NEC Class 2, a Safety Extra Low Voltage (SELV) or a Protected Extra Low Voltage (PELV) power supply to power this adapter. A SELV supply cannot exceed 30V rms, 42.4V peak or 60V dc under normal conditions and under single fault conditions. A PELV supply has the same rating and is connected to protected earth.
Input Voltage Rating	24V dc nominal
DeviceNet Input Voltage Range	11-25V dc DeviceNet specification
Input Overvoltage Protection	Reverse polarity protected
DeviceNet Power Requirements	24V dc (+4% = 25V dc) @ 30 mA maximum

Power Supply Specifications

Power Supply	Note: In order to comply with CE Low Voltage Directives (LVD), you must use either a NEC Class 2, a Safety Extra Low Voltage (SELV) or a Protected Extra Low Voltage (PELV) power supply to power this adapter. A SELV supply cannot exceed 30V rms, 42.4V peak or 60V dc under normal conditions and under single fault conditions. A PELV supply has the same rating and is connected to protected earth.
Input Voltage Rating	24V dc 10-28.8V dc range
Input Overvoltage Protection	Reverse polarity protected
Inrush Current	6 A maximum for 10 ms
PointBus Output Current	1 A maximum @ 5V dc \pm 5% (4.75-5.25)
Field Side Power Requirements, Maximum	24V dc (+20% = 28.8V dc) @ 400 mA
Interruption	Output voltage will stay within specifications when input drops out for 10 ms at 10V with maximum load

General Specifications

LED Indicators	1 green/red Adapter status 1 green/red DeviceNet status 1 green/red PointBus status 1 green System Power (PointBus 5V power) 1 green Adapter Power (24V from field supply)
Power Consumption, Maximum	8.1 W @ 28.8V dc
Power Dissipation, Maximum	2.8 W @ 28.8V dc
Thermal Dissipation, Maximum	9.5 BTU/hr. @ 28.8V dc
Isolation Voltage (continuous-voltage withstand rating)	50V rms Tested at 1250V ac rms for 60 s
Field Power Bus Nominal Voltage Supply Voltage Supply Current	24V dc 10-28.8V dc range 10 A maximum
Dimensions Inches) (Millimeters)	4.41 H x 2.83 W x 2.56 D (112 H x 72 W x 65 D)
Operating Temperature	IEC 60068-2-1 (Test Ad, Operating Cold), IEC 60068-2-2 (Test Bd, Operating Dry Heat), IEC 60068-2-14 (Test Nb, Operating Thermal Shock): 20 to 60°C (68 to 140°F)
Storage Temperature	IEC 60068-2-1 (Test Ab, Un-packaged Non-operating Cold), IEC 60068-2-2 (Test Bb, Un-packaged Non-operating Dry Heat), -40 to 85°C (-40 to 185°F)

ArmorPoint DeviceNet Adapters - 1738-ADN12, -ADN18, -ADN18P, and -ADNX**General Specifications (continued)**

Relative Humidity	IEC 60068-2-30 (Test Db, Un-packaged Non-operating Damp Heat): 5-95% non-condensing
Shock	IEC60068-2-27 (Test Ea, Unpackaged Shock): Operating 30 g Non-operating 50 g
Vibration	IEC60068-2-6 (Test Fc, Operating): 5 g @ 10-500 Hz
ESD Immunity	IEC 61000-4-2: 6 kV contact discharges 8 kV air discharges
Radiated RF Immunity	IEC 61000-4-3: 10V/m with 1 kHz sine-wave 80%AM from 30 MHz to 2000 MHz 10V/m with 200 Hz 50% Pulse 100%AM at 900 Mhz 10V/m with 200 Hz 50% Pulse 100%AM at 1890 Mhz
EFT/B Immunity	IEC 61000-4-4: ±4 kV at 5 kHz on power ports ±3 kV at 5 kHz on signal ports
Surge Transient Immunity	IEC 61000-4-5: ±1 kV line-line(DM) and ±2 kV line-earth(CM) on power ports ±2 kV line-earth(CM) on shielded ports
Conducted RF Immunity	IEC 61000-4-6: 10Vrms with 1 kHz sine-wave 80%AM from 150 kHz to 80 MHz
Emissions	CSPR 11: Group 1, Class A
Enclosure Type Rating	Meets IP65/66/67 (when marked)
Mounting Base Screw Torque	#8 screw, 7.5 in. lbs. in Aluminum, 16 in. lbs. in Steel
Wiring Category ¹	1 - on power ports 1 - on communications ports
Weight Imperial (Metric)	0.80 lb. (0.36 kg)
Certifications: ² (when product is marked)	c-UL-us UL Listed Industrial Control Equipment, certified for US and Canada CE ² European Union 89/336/EEC EMC Directive, compliant with: EN 61000-6-4; Industrial Emissions EN 50082-2; Industrial Immunity EN 61326; Meas./Control/Lab., Industrial Requirements EN 61000-6-2; Industrial Immunity C-Tick Australian Radiocommunications Act, compliant with: AS/NZS CISPR 11; Industrial Emissions ODVA ODVA conformance tested to DeviceNet specifications

1. Use this Conductor Category information for planning conductor routing. Refer to Publication 1770-4.1, Industrial Automation Wiring and Grounding Guidelines.

2. See the Product Certification link at www.ab.com for Declarations of Conformity, Certificates, and other certification details.

Notes:

Quick Start For the 1738-ADNX

What's In This Appendix?

In this Quick Start, you will learn how to use the 1738-ADNX with a ControlLogix system on DeviceNet. You will also use one of the 1738-ADNX's features (Auto Start Mode) in an exercise to automatically configure devices on its Subnet.

When you complete this quick start you will be familiar with:

- The 1738-ADNX as an adapter on the ControlLogix primary DeviceNet network and as a scanner on the DeviceNet expansion Subnet
- Configuring the 1738-ADNX with ArmorPoint I/O on its Subnet
- Using and applying the correct termination of the 1738-ADNX's Subnet
- Using the 1738-ADNX to expand the length of a DeviceNet system
- Using the 1738-ADNX to implement a second baudrate for Subnet devices

For rules and guidelines regarding how to use the 1738-ADNX, see Appendix C of this manual.

Assumptions

A ControlLogix DeviceNet system already exists to which you are going to add new devices without modifying the existing system's architecture. You are going to expand the length of the system beyond its maximum specification and add new devices that can operate at a different baudrate than the existing system.

The existing system attributes include:

- ControlLogix processor in a Logix chassis of 4 or more slots.
- 1756-ENBT (EtherNet/IP) in the Logix chassis.
- Configuration to 125 Kbaud with thin trunk (max distance is 100 m (328 ft.) (ControlLogix chassis may be connected on any DeviceNet network.)
- ControlLogix processor with a 1756-DNB (DeviceNet) in slot 3 (slot 3 was picked for this example. This can be any slot.)

The new Subnet system attributes include:

- Most field devices are more than 100 m from the ControlLogix Processor
- Previously installed and documented at 500 Kbaud
- 1738-ADNX with discrete inputs and outputs for several field devices
- The ability to be replicated several times in the future without changing documentation. (i.e., devices will be replicated with same attributes, node addresses, etc.)

The existing devices will be wired to ArmorPoint I/O.

NetLinX will let you configure everything from your PC, using the 1756-ENBT module and a 1756-DNB. You will be able to connect from your computer over Ethernet to the ControlLogix backplane and configure both the primary (remember the 1738-ADNX will be a new node on this network) and Subnet network (the 1738-ADNX will be node 0 on this network).

When you have completed this exercise you will be able to browse through the 1738-ADNX to see its backplane, using only the RSNetWorx for DeviceNet software package.

1. Open RSNetWorx for DeviceNet by double clicking the icon on your desktop.



2. From the RSNetWorx for DeviceNet main menu select **File>New**.
3. Select DeviceNet configuration.

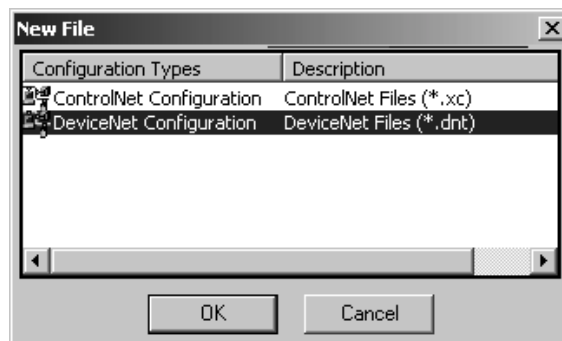

4. Click **OK**.

Now that you have created a new DeviceNet project, go on line by clicking the **Online** icon on the toolbar.

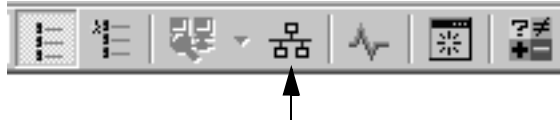

5. A list of the available drivers in RSLinx appears. Drill down from Ethernet into your ControlLogix project through the backplane to your 1756-DNB in slot 3. Select channel A, as shown below.

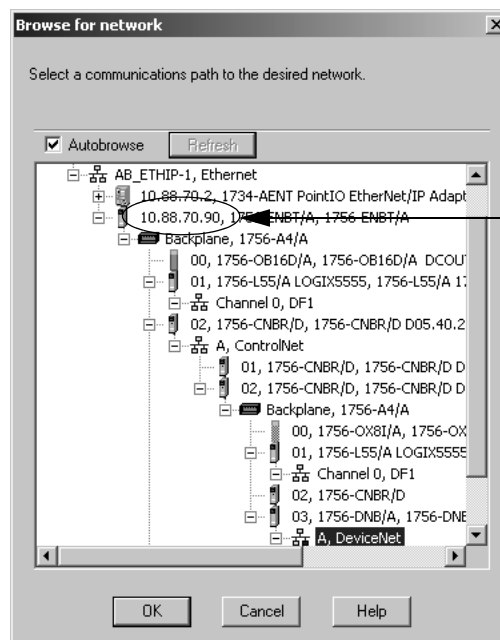

Your system may not be configured as illustrated. You must pick an Ethernet driver that is configured with the address of your ControlLogix 1756-ENBT bridge module.

The sticker on the front of your 1756-ENBT module identifies the IP address configured for your module.

6. Click **OK** to accept the path configuration.

7. Click **OK** to the prompt.

RSNetWorx will go on line. A screen similar to the one below will appear:

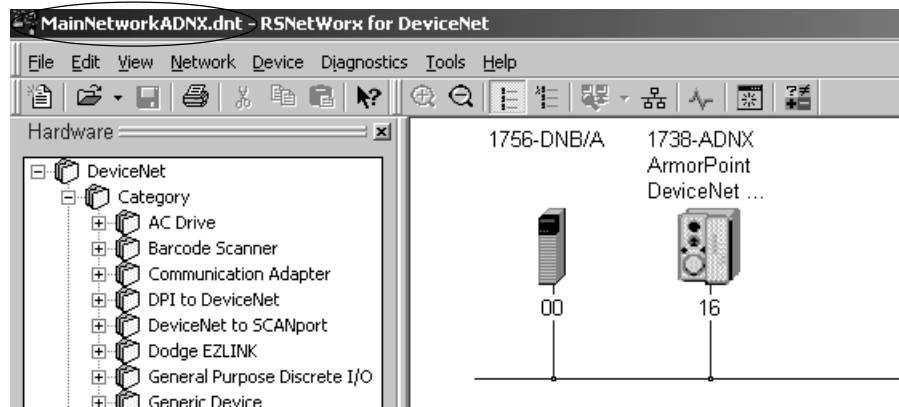

Your system may not look like the above system. (You may have more nodes.) It is only important to verify that you have the 1756-DNB at node 0 and the 1738-ADNX at node 16.

8.  After the browse is complete, from the RSNetWorx for DeviceNet main menu select **File>Save As**.
9. Type in **MainNetworkADNX** as the filename (use this exact name to avoid confusion later).
10. Click **Save**.

On the main network, the 1738-ADNX acts as an adapter.

- The rotary switches on the front of the 1738-ADNX should be set to node 16.
 - Verify your browse reported the 1738-ADNX at node 16.
 - Later you will browse deeper to see the Subnet. (Note that on the Subnet, the 1738-ADNX acts as a scanner and is always at node 0 on that network.)
11. Download a blank scanlist to the 1756-DNB.
 - a. You do not want the existing program in our Logix processors to interfere with clearing the scanlist. To ensure that this does not occur, use the key switch to put all the processors in program mode then back to remote program (turn the keys right then back to the middle position).
 - b. Double click the 1756-DNB to bring up its properties page.

c. Select the **Scanlist** tab and when prompted click **Download**.

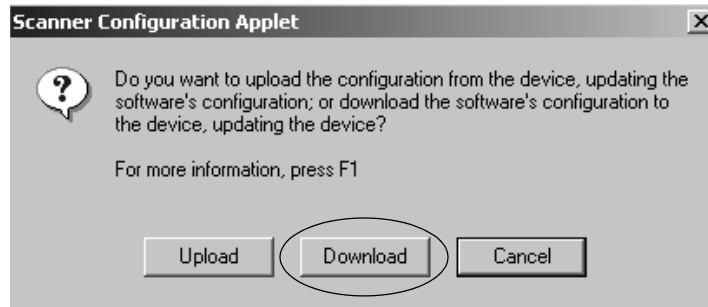

12. When the download is complete, add the 1738-ADNX to the scanlist by selecting the 1738-ADNX (node 16) and clicking the single right arrow.

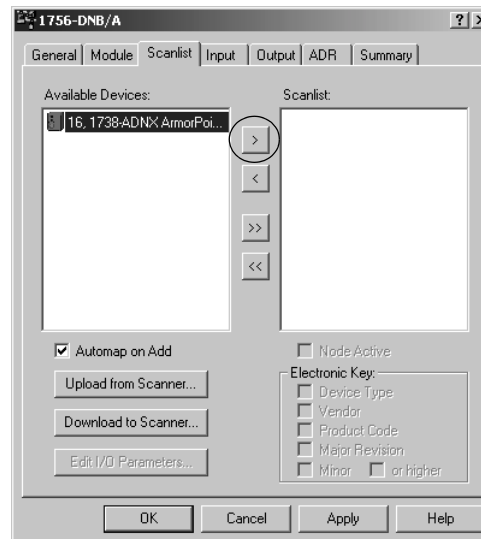

A warning window opens that says that the 1738-ADNX does not contain any I/O data.

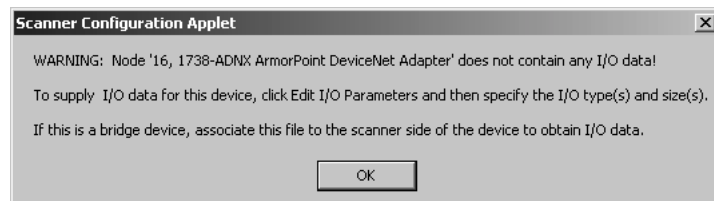

At this point, RSNetWorx for DeviceNet does not know how many bytes of data are being inputted and outputted to the Subnet so it cannot fill in the values for you.

13. Press **OK** to close the warning window.

14. To verify that there are no data for input and outputs, click the 1738-ADNX in the **Scanlist** window.

15. Click Edit I/O Parameters.

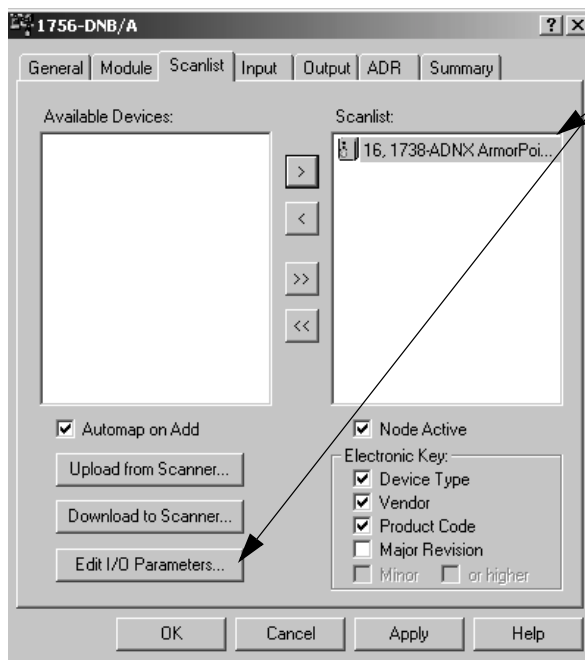

Click the 1738-ADNX in the Scanlist and then click **Edit I/O Parameters** to verify input and output bytes.

16. Verify that nothing is filled in for input and output sizes (both are zero). If you knew how much data was being produced and consumed on the Subnet, you could fill these fields in manually. Because it is easier to let RSNetWorx for DeviceNet fill in these values for us, click **Cancel** to close this window.

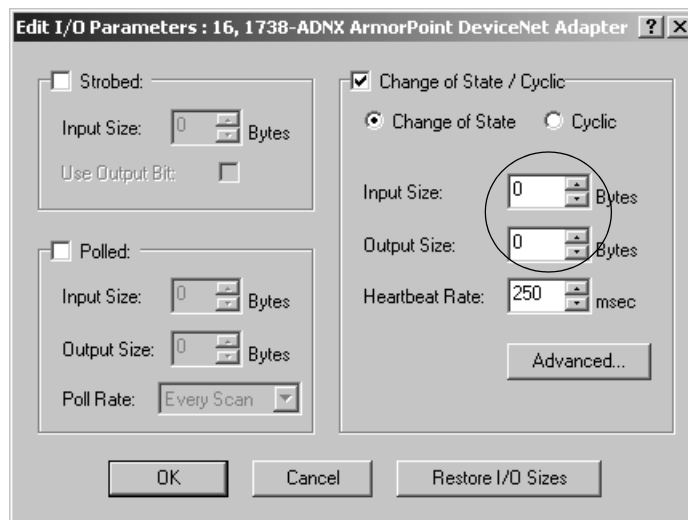

17. Remove the 1738-ADNX from the scanlist for now by clicking the double arrows.

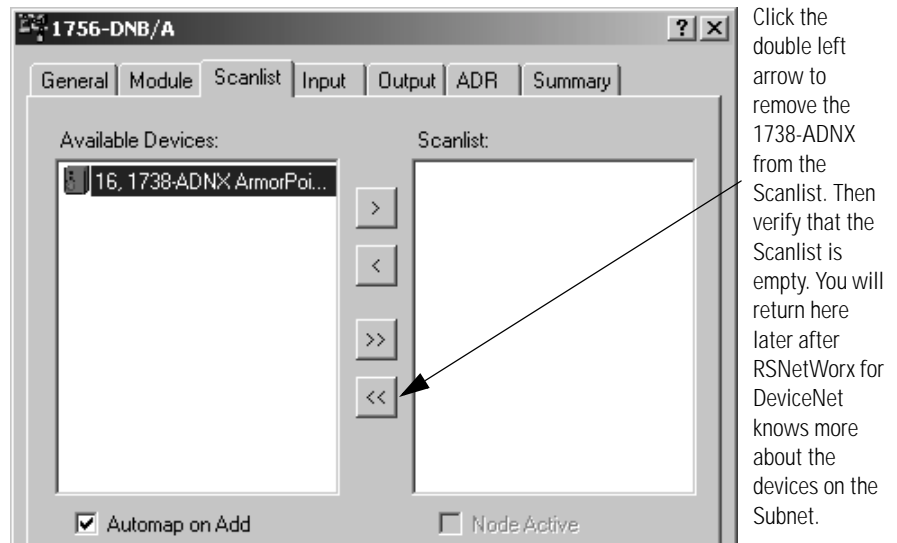

18. Click **OK**. When prompted if you want to download changes to the device, click **Yes**.

At this point you have a choice:

- You could start another instance of RSNetWorx for DeviceNet and configure the Subnet. You would then see the 1738-ADNX at node 0 on the Subnet and add the ArmorPoint I/O to its scanlist. You would then map the data to the exact location you want it. For example, if ladder logic was already written, you could map it to an address.
 - If you have not written your ladder logic yet and you are not particular about the mapping, you could use the auto start feature of the 1738-ADNX to map all the devices automatically from the primary network. After the mapping is complete, look at the Subnet to verify that everything worked as expected.
19. Verify that the subnetwork taps are electronically isolated and have their own terminating resistors at each end.

IMPORTANT

The Subnet must always be properly terminated. In this example, there is a terminating resistor at each end of the Subnet trunk.

To properly terminate the 1738-ADNX when using a Subnet, refer to the illustration.

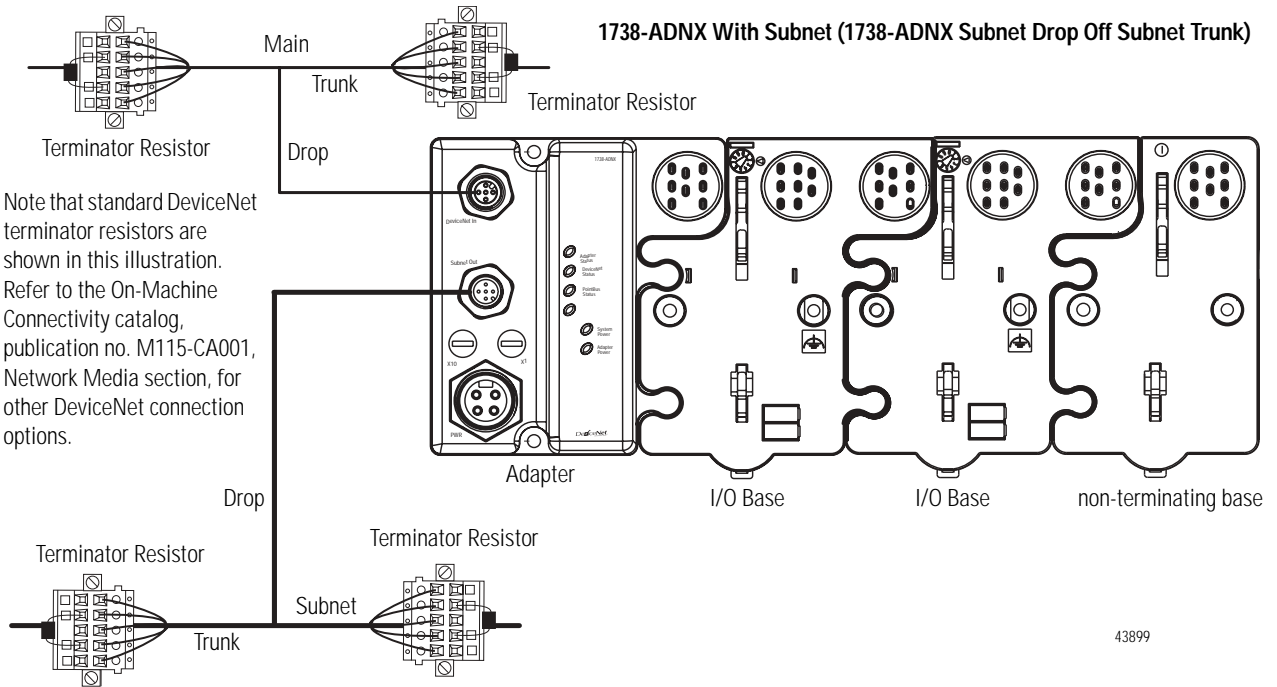

- If you are not going to use the Subnet, you must still terminate it!
- Note that the non-terminating base is shipped with the 1738-ADNX only. The terminating base is shipped with all the other ArmorPoint DeviceNet adapters.
- Do not use carbon resistors. Metal film is recommended.

Continue ONLY after you have verified that the taps are terminated correctly.

20. Double click on the 1738-ADNX to open the properties window. In the next step you will download the EDS defaults to the 1738-ADNX.

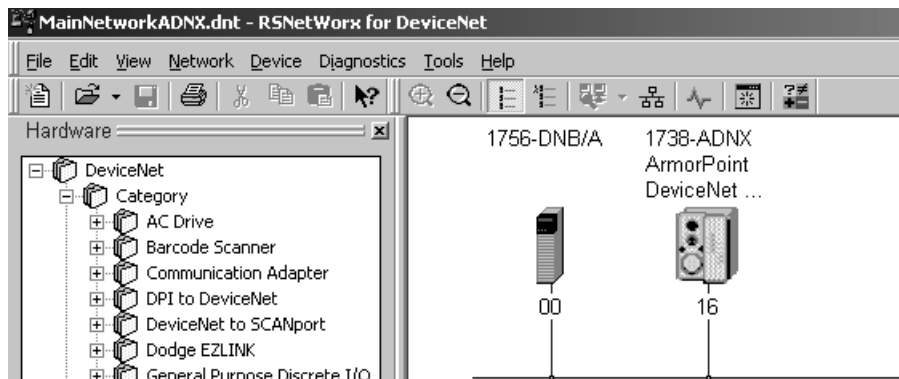

21. Select the **Parameters** tab and choose **Download**.
22. Verify that your window looks similar to the following window.

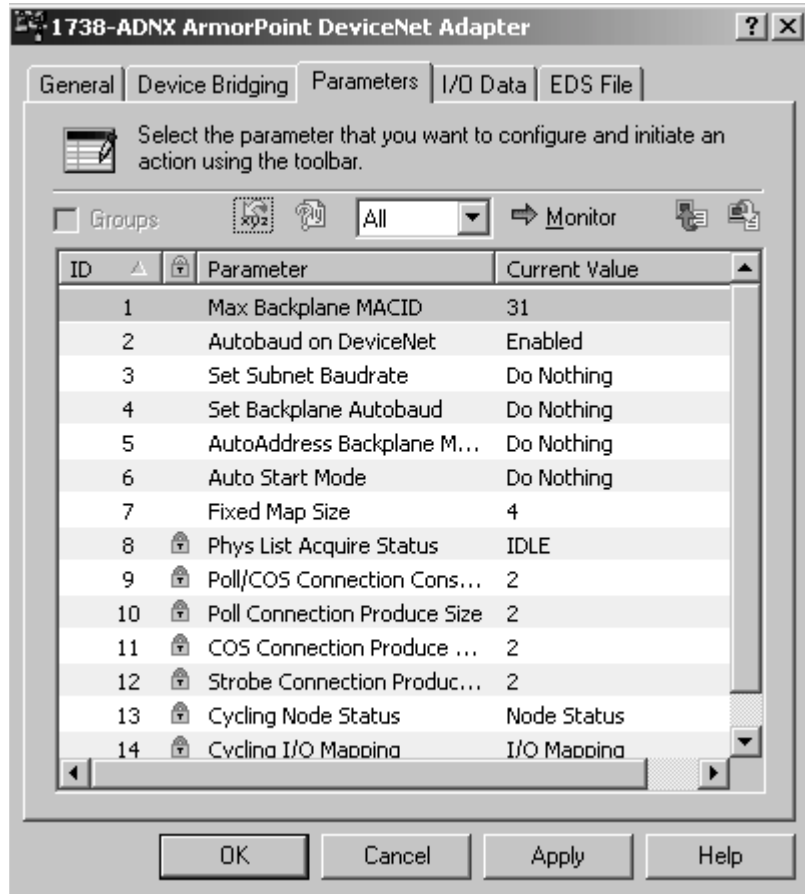

Review of the 1738-ADNX Rules and the MACID Parameter

To understand some of the MACID parameters, you should review some of the rules for using the 1738-ADNX.

- The 1738-ADNX always has address 0 on the Subnet.
- All ArmorPoint I/O backplane module MACIDs must be numerically less than those of non-backplane Subnet modules.
- Each backplane module's MACID must be greater than that of its left neighboring module.
- The 1738-ADNX has a unique attribute: **Max(imum) Backplane MACID**. This value represents the highest node address of a module residing on the backplane. This value must be greater than or equal to the rightmost backplane ArmorPoint I/O module, but must be less than that of any non-backplane Subnet module. You select this value to allow for the future addition of backplane modules. The attribute's default value is 31, representing the middle of the address range.

- The 1738-ADNX will automatically maintain the MACIDs of the backplane modules.
- Note that the assignment of the MACIDs of the non-backplane subnet modules is manual and is not performed or retained by the 1738-ADNX.
- The 1738-ADNX supports 125 kb, 250 kb, and 500 kb baudrates. For this example, you are going to set the Subnet to 125 kb.

When using Auto Start Mode, the adapter:

- Sets all ArmorPoint I/O modules on the backplane to Autobaud.
- Reads all ArmorPoint I/O module IDs on the backplane.
- Sets the ArmorPoint I/O module addresses sequentially.
- Sets the Max Backplane MACID.
- Generates a scanlist for the backplane.
- Maps automatically I/O data, based on byte (I/O data is mapped in the adapter's memory at the next available byte), word (I/O data is mapped at the next available word), double-word (I/O data is mapped at the next available double word) or fixed (the data is mapped to a fixed allocation size). You will choose one of these four options from a pulldown menu later in this Quick Start.

IMPORTANT

Your 1738-ADNX DeviceNet adapter must be free of I/O connections when you use Auto Start Mode. If another scanner device has established I/O connections with the adapter (if it is mapped in another scanner's scanlist), the attempt to use Auto Start Mode is rejected. Also, when the adapter is configuring itself in Auto Start Mode, no other device can establish I/O connections to the adapter.

When the adapter completes this sequence of events, the ArmorPoint I/O modules connected to the adapter are ready to accept connections from a scanner.

IMPORTANT

Although Auto Start Mode lets your adapter operate with a default configuration, you can choose to manually change the configuration after operation has begun or you can write a custom configuration.

When Auto Start Mode is used, the adapter and connected I/O modules go through the following sequence of events:

- Connections are established to I/O modules
- The adapter makes Change of State (COS) connections if the I/O module supports COS, if not, the connection is Polled
- Data is mapped to the connections

The notes above explain parameter 1 – Max Backplane MACID. Next you will review parameter 6, Auto Start Mode and parameter 7, Fixed Map Size.

Review of Auto Start Mode

1. Select parameter 6, then click the help icon to display information about Auto Start Mode.

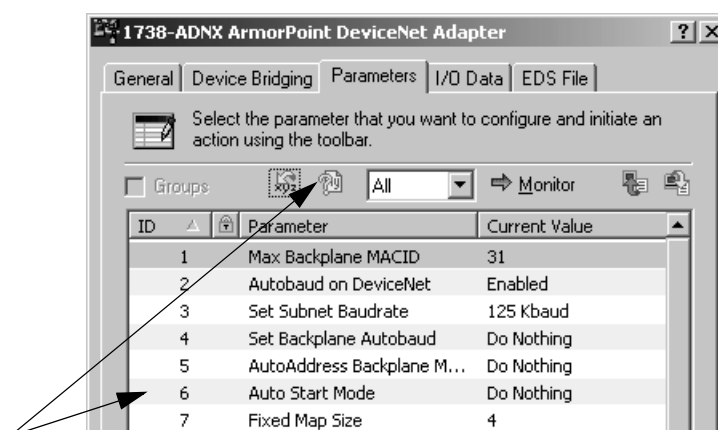

A window describing Auto Start Mode opens.

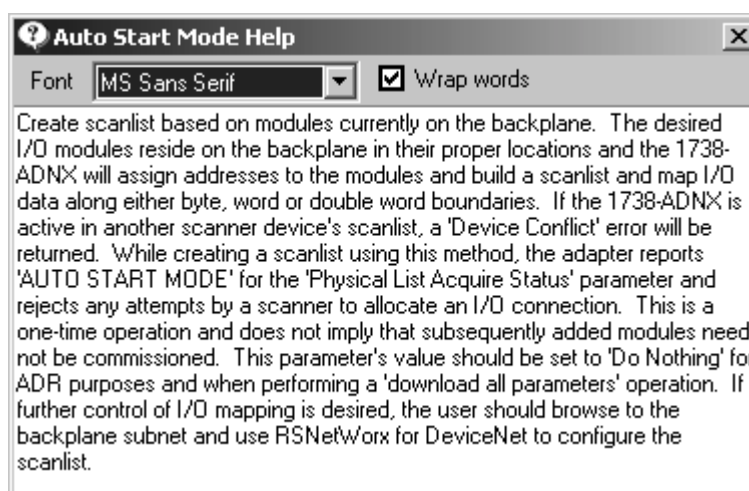

Right now, the 1738-ADNX is not in another scanner's scanlist so you can use the Auto Start Mode feature. By using Auto Start Mode, the 1738-ADNX will map all the devices on the Subnet and automatically adjust the value for the following parameters:

- 1, Max Backplane MACID
 - 9, Poll/COS Connection Consume Size
 - 10, Poll Connection Produce Size
 - 11, COS Connection Produce Size, and
 - 12, Strobe Connection Produce Size.
2. Select the pulldown box next to the **Auto Start Mode** parameter. You can map the data using the four options discussed earlier. If you choose to use the **Map Data With Fixed Map Size** option, the map size is selected with parameter 7, **Fixed Map Size**.
 3. For this example, choose **Map Data To Word Boundaries** as shown below:

Parameter	Current Value
Max Backplane MACID	31
Autobaud on DeviceNet	Enabled
Set Subnet Baudrate	125 Kbaud
Set Backplane Autobaud	Do Nothing
AutoAddress Backplane Modules	Do Nothing
Auto Start Mode	Map Data With Fixed Map
Fixed Map Size	Do Nothing
Phys List Acquire Status	Map Data To Byte Boundaries
Poll/COS Connection Consume Size	Map Data To Word Boundaries
Poll Connection Produce Size	Map Data To DWord Boundaries
COS Connection Produce Size	Map Data With Fixed Map Size

Notice that parameters 9, 10, 11 and 12 are still at their default of 2 bytes. These values will be filled out for you when this action is complete.

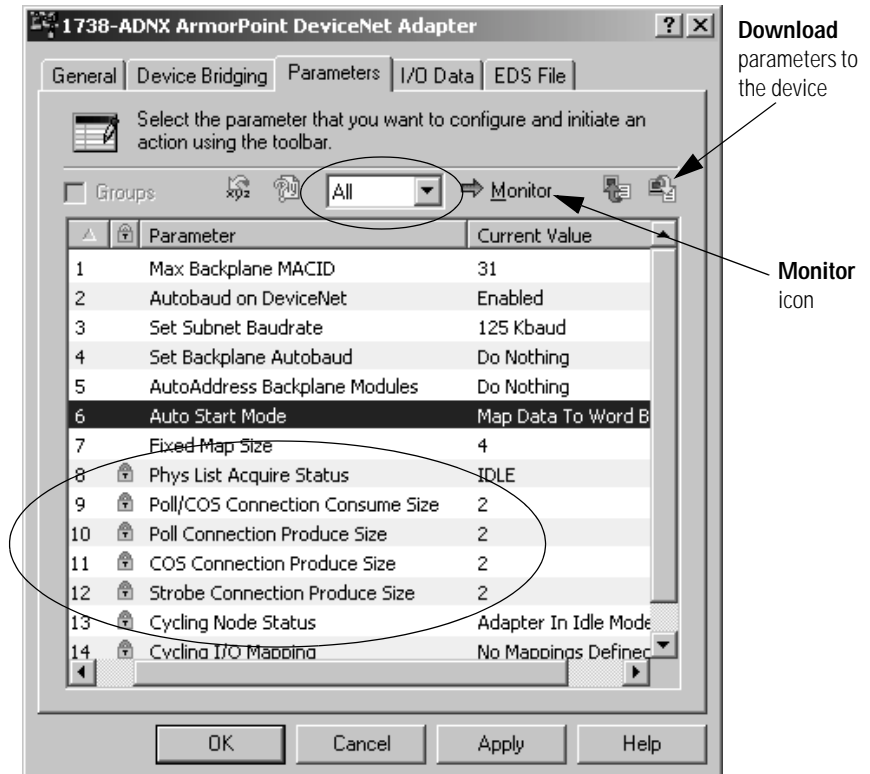

4. Make sure **All** is selected and the **Monitor** value then click the icon to download parameters to the device (this triggers the Auto Start Mode).
5. Click the **Monitor** icon and notice:
 - Parameter 6 has gone back to **Do Nothing**. The Auto Start has begun and will not repeat unless you trigger it again later.
 - Parameter 8, **Phys List Acquire Status**, indicates you are in Auto Start Mode. Give the system at least a minute or two to complete the configuration you requested then go to the next step.

Auto Start Mode	Do Nothing
Fixed Map Size	4
Phys List Acquire Status	AUTO START MODE

6. Wait for parameter 8 to return to idle. Then click the **Monitor** icon to end monitoring. Notice the following:
 - Parameter 1 has been filled in for you. There are three ArmorPoint I/O modules in the backplane, causing the default to change from 31 to 3.
 - Parameter 3: **Verify the Backplane Baudrate is 125 Kbaud. If it is not, you will need to find out why and make the necessary corrections.**
 - Parameter 9, 10, 11, and 12 have been filled in for you.

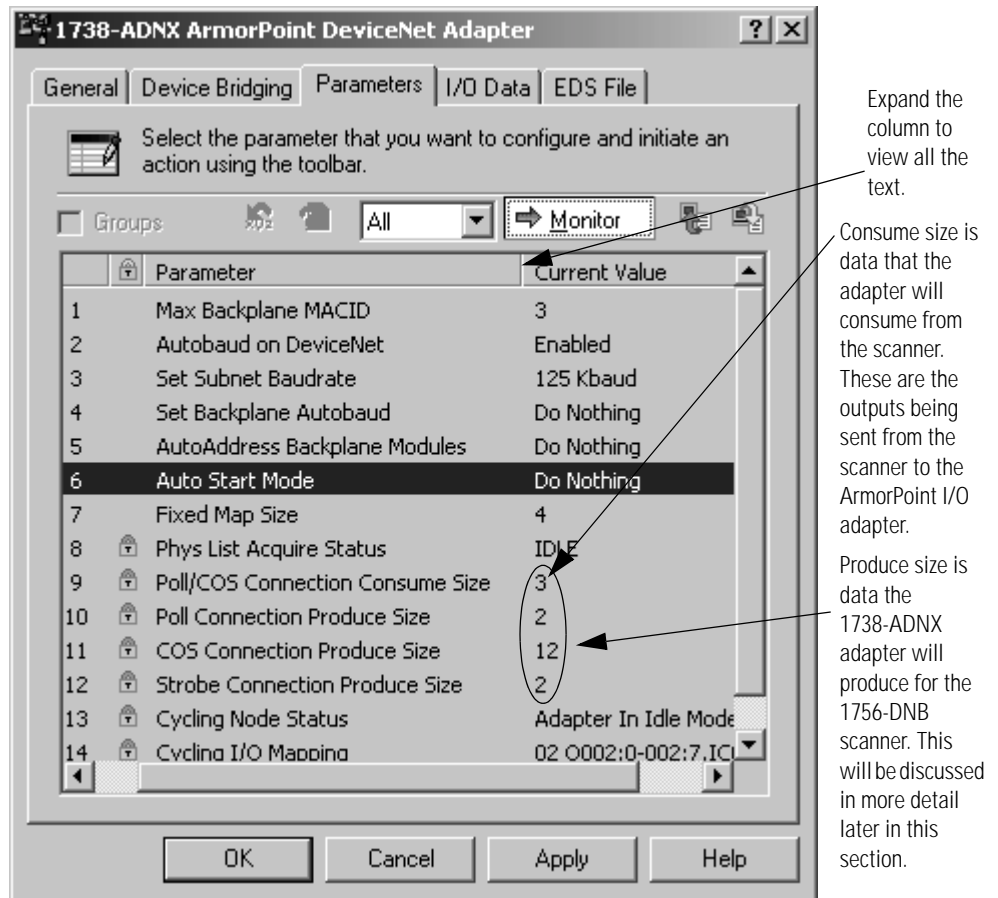

Note that you do not need to view the Subnet to determine where the data has been mapped. You can go back to monitor mode and view parameter 14, **Cycling I/O Mapping**. The help for this parameter states how to use the parameter to determine mapping.

14 Cycling I/O Mapping 02 0002:0-002:7,IC

7. Press **OK** to close this window.

8.  From the RSNetWorx for DeviceNet main menu, select **File>Save**.

IMPORTANT

You must save your work before moving on.

Browse the Subnet

Look at the Subnet at this point to make things more clear.

1. From the RSNetWorx for DeviceNet main menu, select **File>New** and then select **DeviceNet Configuration**.
2. Click **OK**.

Now that you have a new DeviceNet project created.

3. Click the **Online** icon.

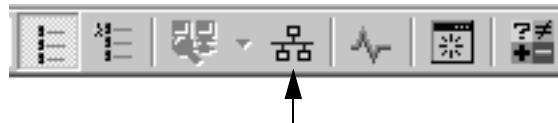

Last time you browsed to the 1756-DNB. This time you will browse a little deeper.

4. Drill down from Ethernet into your ControlLogix demo box through the backplane to your 1756-DNB in slot 3, channel A, 1738-ADNX and select DeviceNet Subnet as shown below:

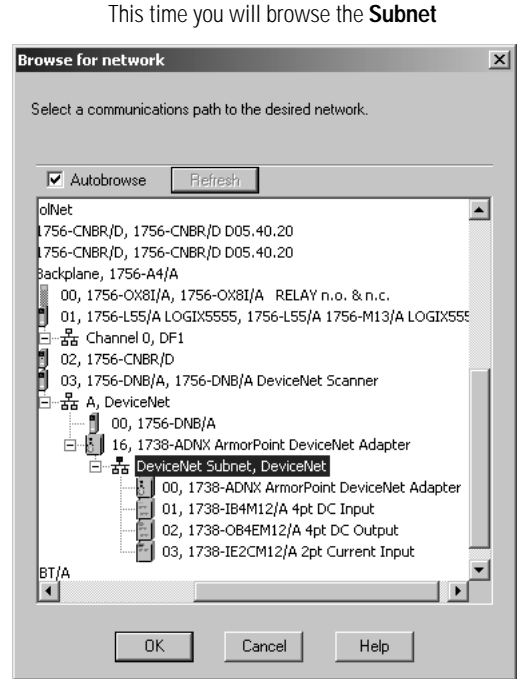
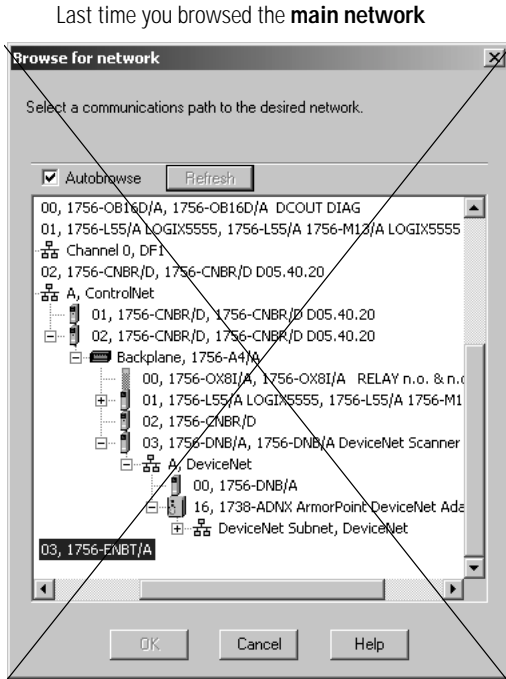

5. To go on line, click **OK** to accept the path configuration and then **OK** to the prompt.

Wait for the browse to complete.

6.  From the RSNetWorx for DeviceNet main menu, select **File>Save As**.
7. Type in **SubNetADNX** as the filename.
8. Click **Save**.

IMPORTANT You must save your work before continuing.

9. Verify your screen appears as shown below.

The nodes can be in any order. Verify:

- All four are there
- They have the correct node numbers

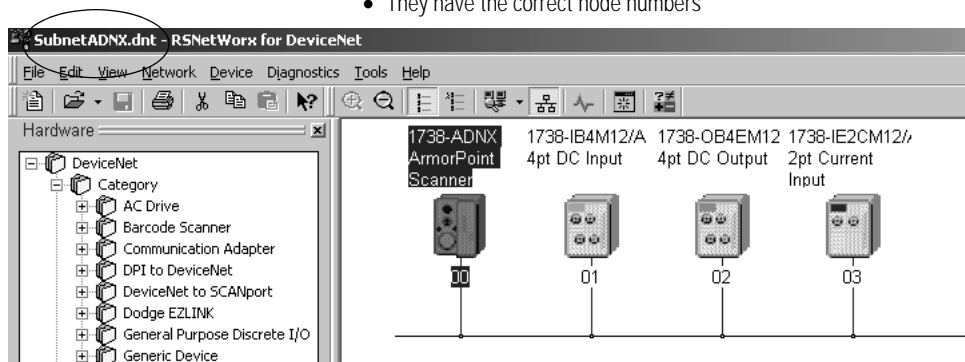

On the Subnet, the 1738-ADNX is a scanner and it is always at node 0. It is OK for some or all of the node numbers on the Subnet to be the same as devices on the primary network. Because they are two different networks, duplicate node errors will not occur. The 1738-ADNX will communicate back to the 1756-DNB scanner as a single entity (only taking up one node number on the main network).

To view the configuration you just created, upload the scanlist from the 1738-ADNX.

10. Double click on the 1738-ADNX to bring up its properties page.

11. Select the **Scanlist** tab and when prompted select **Upload**.

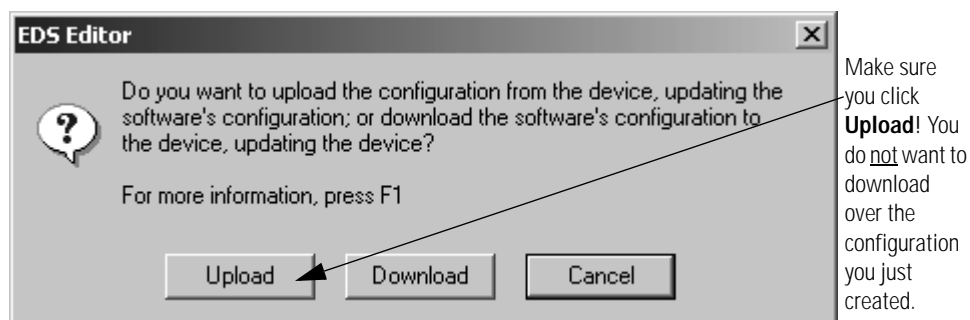

- Verify your scanlist matches that shown below.

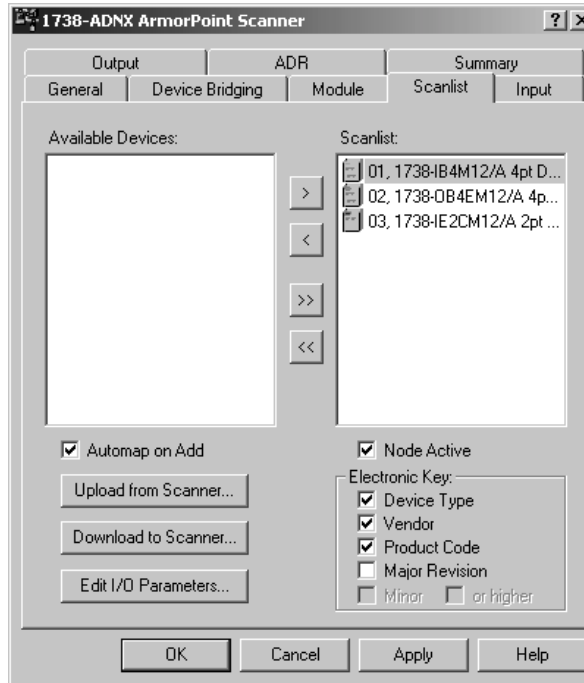

- Notice that all the ArmorPoint I/O modules have been added to the scanlist, as you probably expected.

You are about to look at the input and output tabs. Based on your selections earlier, all the data should be mapped to word boundaries.

Inputs and Outputs

1. Select the **Input** tab. A single word is 16 bits. Notice that the mapping is as expected.
 - The first two bytes (1 byte = 8 bits) are reserved as read only.
 - The first word is completely used, so the 1738-IB4M12 can map to the beginning of the next word (byte 2, bit 0).
 - There is a space between the 1738-IB4M12 and the 1738-OB4EM12 because the next word does not start until byte 4.

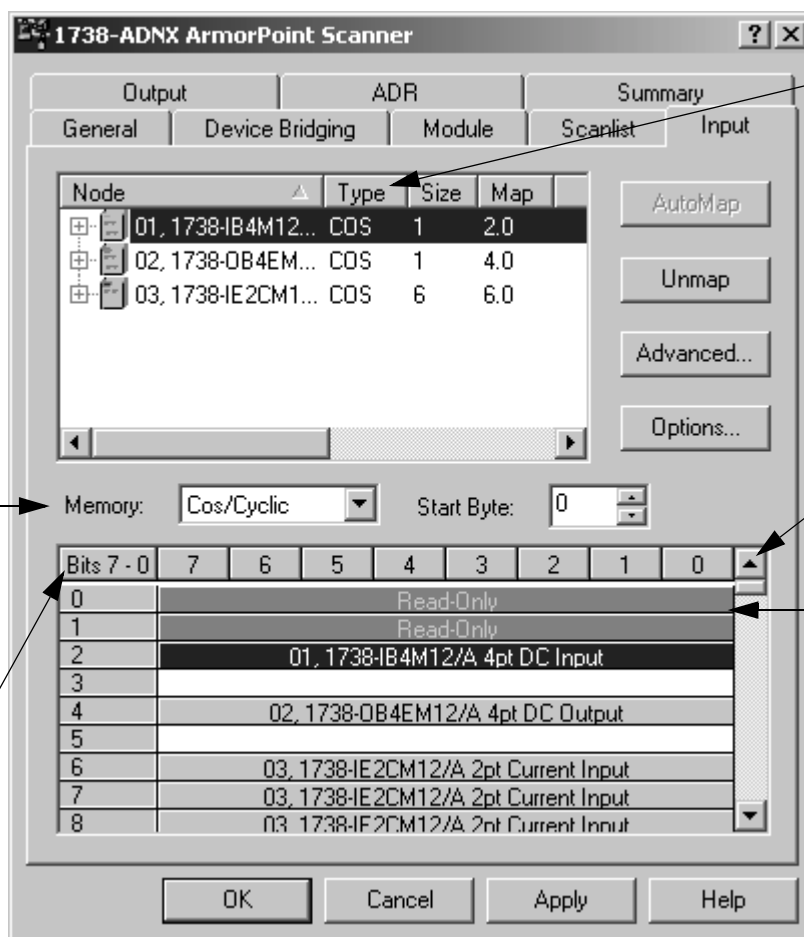

This field describes how the data is transferred between the I/O modules and the adapter on the PointBus Subnet.

The current memory buffer selected is COS/Cyclic. There are also buffers for Polled and Strobed. This is how the data will be transferred to the scanner (1756-DNB in this example).

Use the scroll bar as needed to see all of the data.

The first 2 bytes are reserved for status.

Note the mapping in the 1738-ADNX Scanner is shown in byte increments. The 1756-DNB displays in double words (4 bytes).

Scroll down and notice that bytes 0 through 11 = **12 bytes total** were enough for the input data.

7	03, 1738-IE2CM12/A 2pt Current Input
8	03, 1738-IE2CM12/A 2pt Current Input
9	03, 1738-IE2CM12/A 2pt Current Input
10	03, 1738-IE2CM12/A 2pt Current Input
11	03, 1738-IE2CM12/A 2pt Current Input
12	
13	

This matches what you observed earlier on the main network:

Earlier view of the parameters.

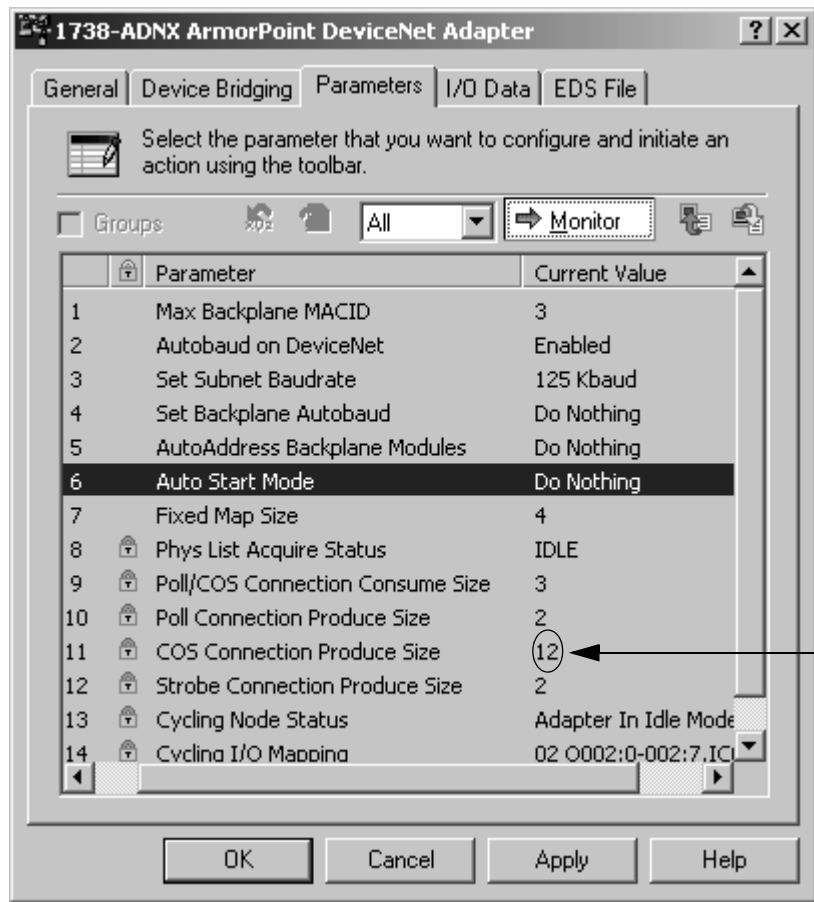

- The data mapped in the 1738-ADNX will be exchanged with the 1756-DNB scanner.
- There are three memory buffers that the 1738-ADNX uses for input data to the scanner on DeviceNet. The buffers are COS/cyclic, polled, and strobed. You can map data into any of the three buffer areas on the adapter.
- Currently, all of the I/O modules are mapped to the COS/cyclic buffer.

2. Select the pulldown listbox next to the **Memory** label in the middle of the window to display the three memory buffer choices.
3. Select each of the choices and view the mapping. You will see that only the COS/cyclic buffer is being used (There are 2 bytes reserved for status in each buffer. These words are not for a specific module.)
4. Set the **Memory** selection back to COS/cyclic.

Note that for the 1738-ADNX, each line in the mapping area represents a byte of data. When you view the 1756-DNB, each line will be 4 bytes of data (double word).

Now you are ready to take a look at the output side. Based on the numbers you saw on the main network you expect to see 3 bytes (two of them are going to be reserved status words).

Earlier view of the parameters.

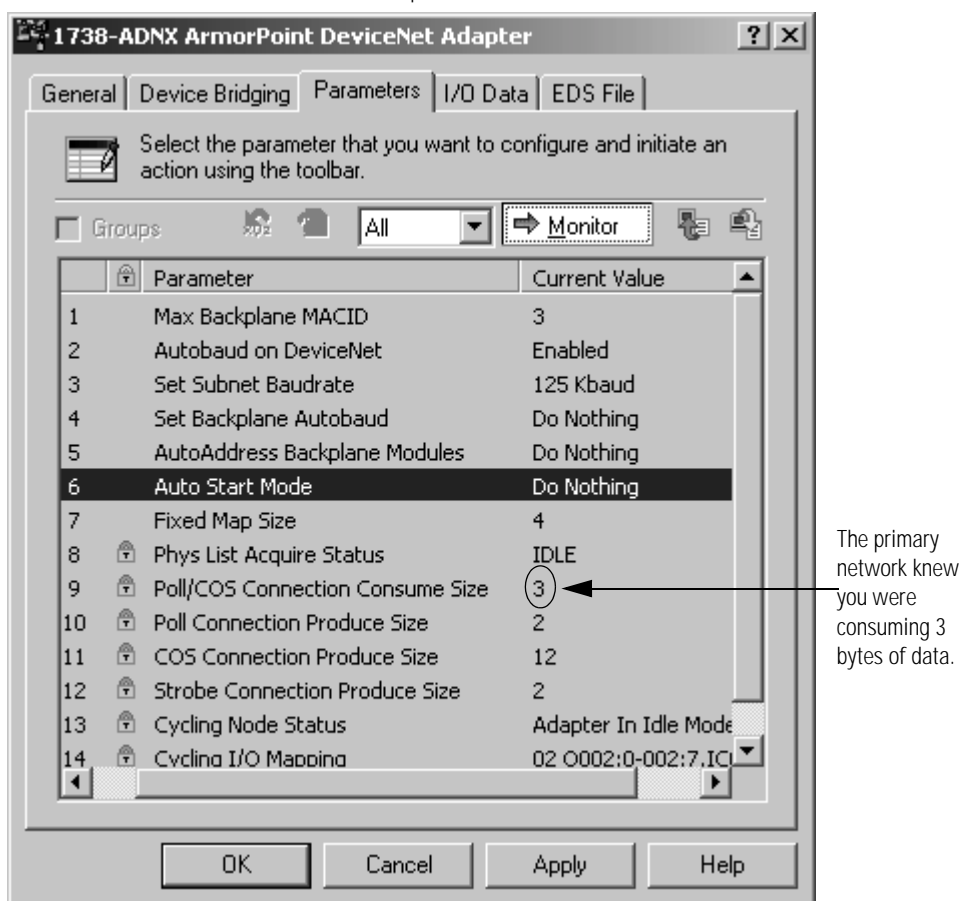

You should still be looking at the subnet 1738-ADNX **Input** tab. Now select the **Output** tab and verify you have the following:

- Notice that only the output module 1738-OB4EM12 appears.

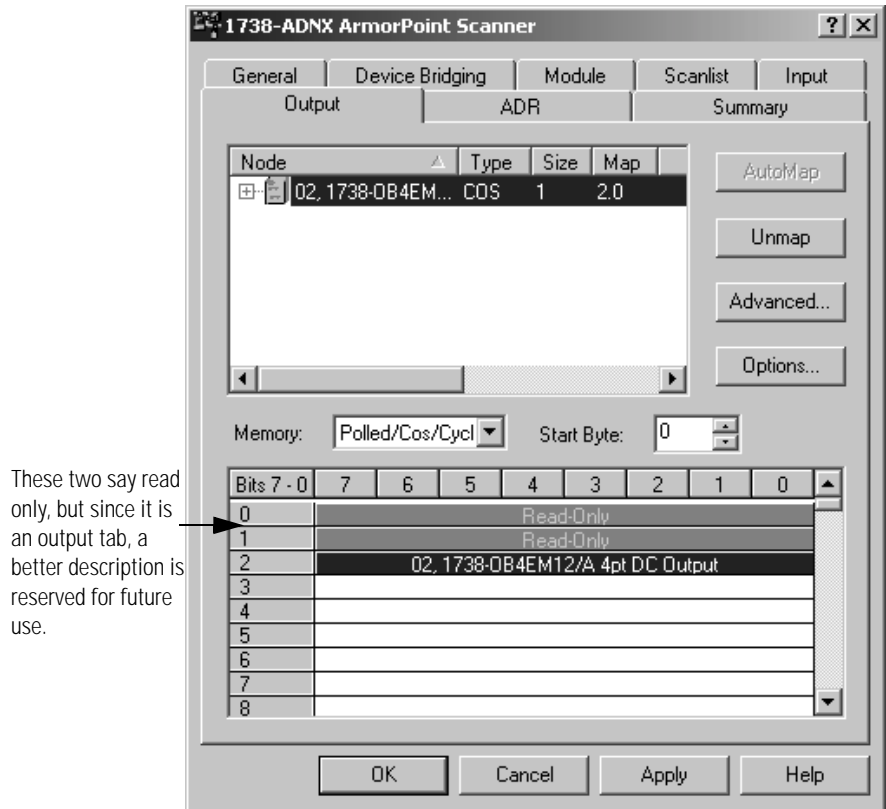

5. Expand the plus next to node 2.

- Several revisions ago (RSNetWorx for DeviceNet V3.21) the ability to view I/O details from the **Input** and **Output** windows was added into the software.
- From the **Input** and **Output** windows, you can view detailed I/O information for each device in the scanlist of a DeviceNet scanner.
- To view the I/O details for a particular device, click the plus sign (+) located to the left of the device. If a plus sign is not displayed, there are not any I/O details for that device.
- This feature is driven by each device's EDS file.

- Select Output Value #1 and notice the exact location of that bit is displayed. You can easily tell that Output Value #1 is in byte 2, bit 1 (see the highlighted portion of byte 2). This information will make it very easy to write your ladder logic later.

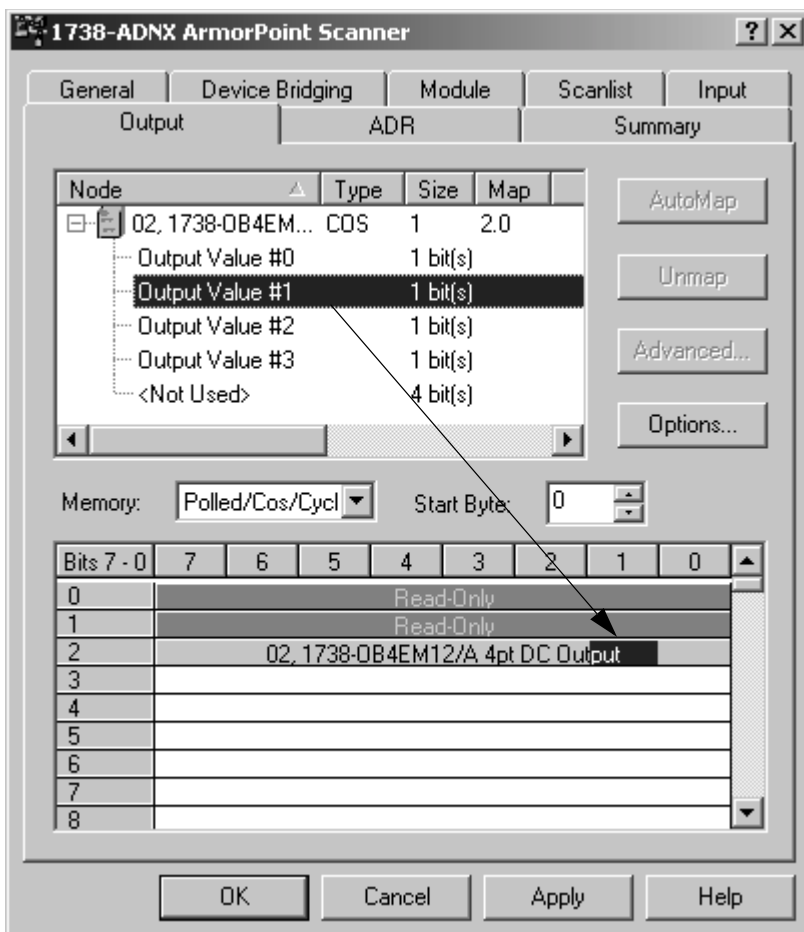

You uploaded the scanlist and looked at the input and output data. Now you are about to save this information to your hard disk.

- Click **OK** (not cancel) to close this window.

Click **OK** and not **Cancel** to close the window.

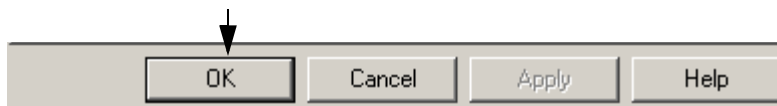

8.  From the RSNetWorx for DeviceNet main menu, select **File>Save**.

IMPORTANT

You must save your work before moving on.

Now all the information is saved in the file **SubnetADNX.dnt**.

Navigate Between Networks

A nice feature of RSNetWorx for DeviceNet is the easy way it lets you commission the Subnet. You can have two DeviceNet projects because there are actually two DeviceNet networks. Another nice feature of RSNetWorx for DeviceNet is the easy way it lets you navigate between two related networks rather than having to keep track of which network file goes with what.

RSNetWorx for DeviceNet provides an easy way to associate two networks that will allow quick navigation between them. You will look at that now.

1. Double click on the 1738-ADNX icon to pull up its properties page.

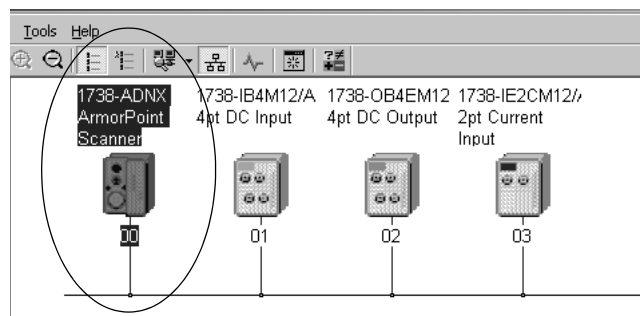

2. Select the **Device Bridging** tab. The following window opens.

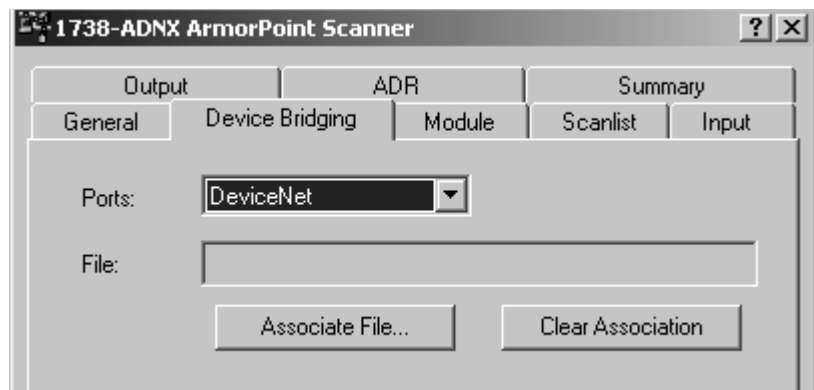

This window lets you define a file that is associated with this one through the 1738-ADNX. Once you specify the associated file, you will be able to jump to that file through a menu selection from the 1738-ADNX. The file you need to associate in this case is the **MainNetworkADNX.dnt** project file you created earlier.

3. Click the **Associate File** button.
4. Make sure you are looking in the **Networks** folder in the path shown below.



5. Select **MainNetworkADNX.dnt** then the **Open** button. The MainNetworkADNX.dnt file will appear in the **File** box as shown below.

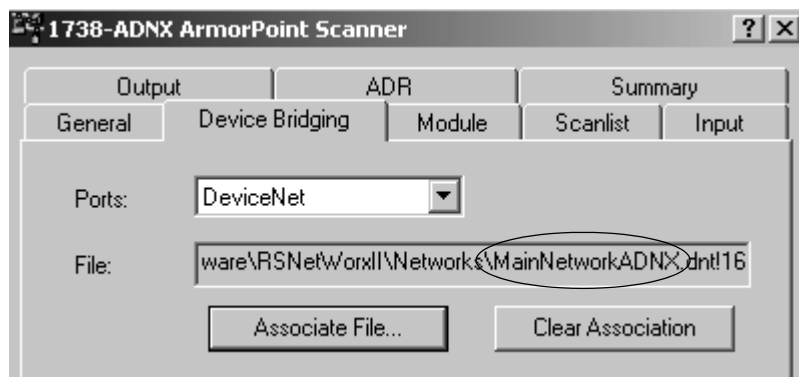

6. Click **OK** to close the properties window.

7.  From the RSNetWorx for DeviceNet main menu, select **File>Save**. Now you can observe how you would switch networks.

Switch Between Networks

1. Move the cursor over the 1738-ADNX in the network browse window.
2. Press the right mouse button.
3. Click **Associated Network** from the menu.

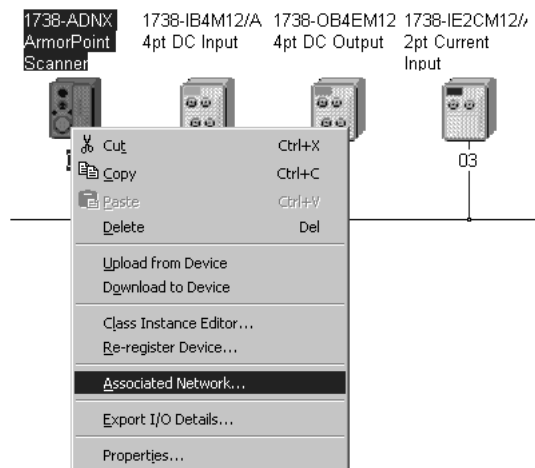

If prompted to save your changes, you must select **Yes** (you will probably not get this prompt if you saved earlier).

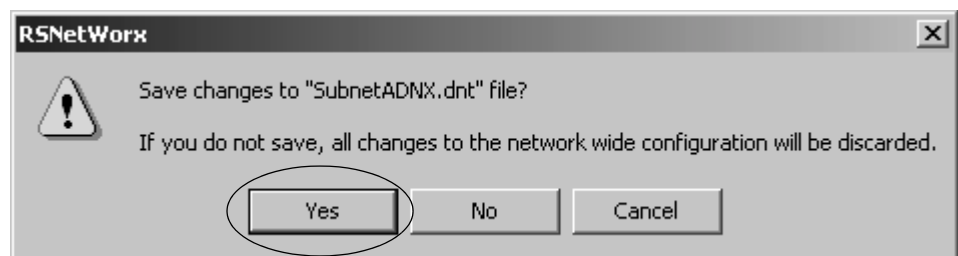

To get back to the main network, associate the **SubnetADNX.dnt** project to **MainNetworkADNX.dnt** using the following steps:

4. Double click on the 1738-ADNX adapter at Node 16.
5. Click the **Device Bridging** tab.

- Click **Associate File** to associate the **SubnetADNX.dnt** file to the main network.

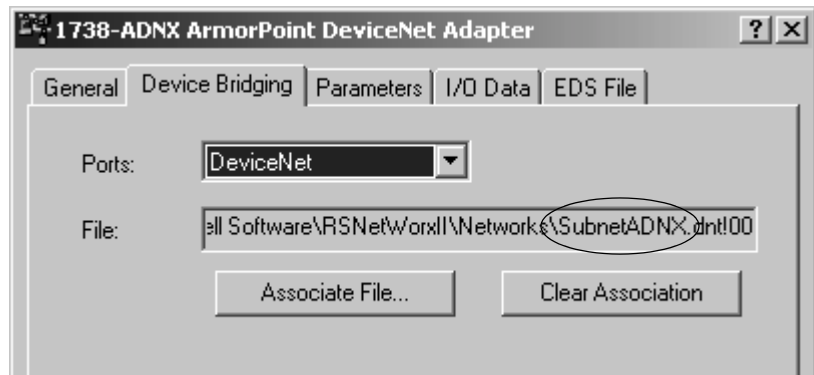

- Press **OK** (not cancel) to save the association.

Now that they are associated, you can easily jump between the main network and the Subnet and vice versa. Another advantage is that the main network has access to the information saved in Subnet.dnt.

- Click the **Online** icon.

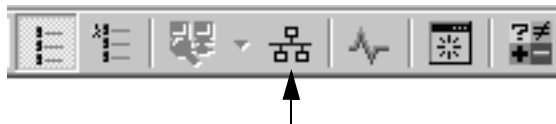

- If prompted to save, click **Yes**.
- At the prompt, click **OK**.
- Let the browse finish then double click on the **1756-DNB** icon to pull up its properties.
- Click the **Module** tab and if prompted choose **Upload**.

13. Change the slot number to 3 (see illustration below) so it matches the 1756-DNBs location in the 1756-Rack. Then click the **Scanlist** tab.

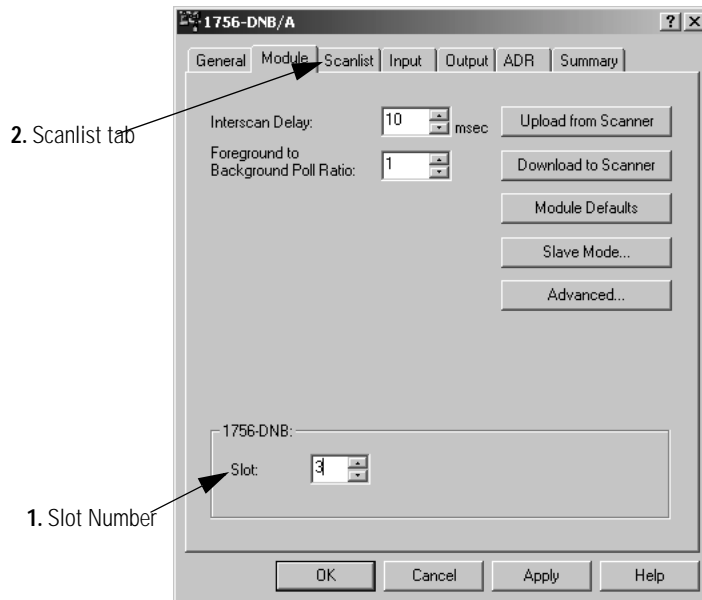

14. Select the 1738-ADNX and then used the single right arrow key to add it to your scanlist.
 - Notice that you did not get the error message that you received earlier, when you were told that the 1738-ADNX ArmorPoint I/O DeviceNet Adapter does not contain any I/O data.
 - When you selected the **Edit I/O Parameters** button, you found that no values were filled in the **Input** and **Output** fields.
 - Now that you have looked at the Subnet, saved the information, and associated the main network with the Subnet, most of the information is now available from the main network.

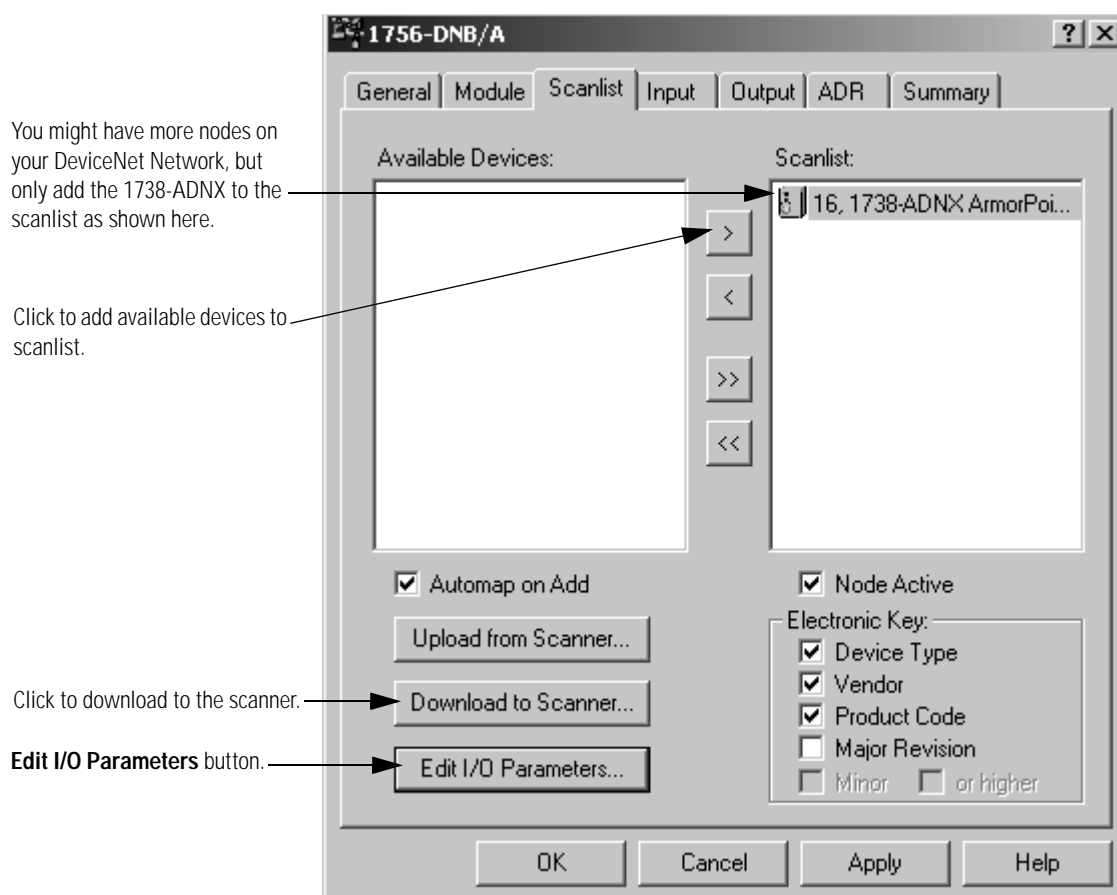

15. Select the 1738-ADNX in the Scanlist and then click **Edit I/O Parameters**.

Notice the fields have been filled in for you.

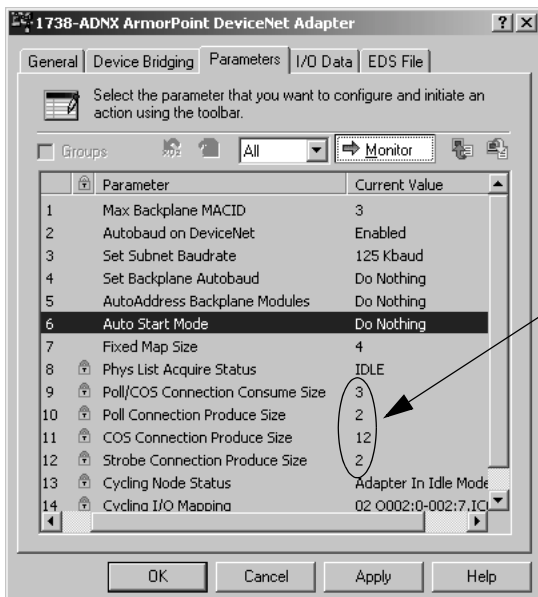

The values match what was observed earlier.

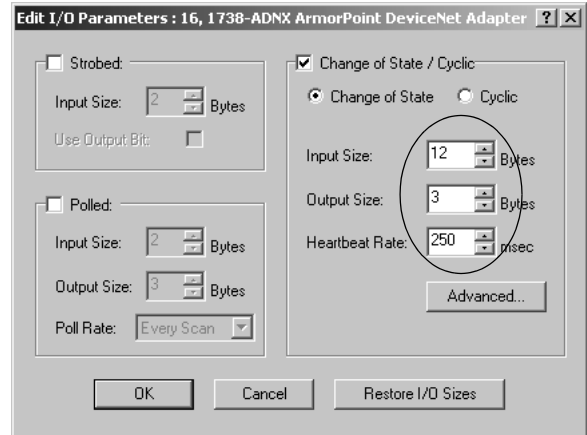

Values observed earlier.

- The 1756-DNB scanner will be receiving 12 bytes of data that the 1738-ADNX produces.
- The 1756-DNB scanner will be outputting 3 bytes of data that the 1738-ADNX consumes such as the 1738-OB4EM12 outputs.

Sometimes it is easy to get confused and reverse the numbers if these values are entered manually (in this case, entering incorrectly input size = 3 and output size = 12). It is a nice feature that RSNetWorx for DeviceNet fills these values in for you.

- On the main network, the 1738-ADNX is acting as an adapter so it is producing those twelve bytes of data for the 1756-DNB. You are now configuring the 1756-DNB, so those twelve bytes get filled for Input Size as shown above.

16. Click **Cancel** to close the **Edit I/O Parameters** window.

17. Click the **Input** tab and expand the plus sign next to the 1738-ADNX.

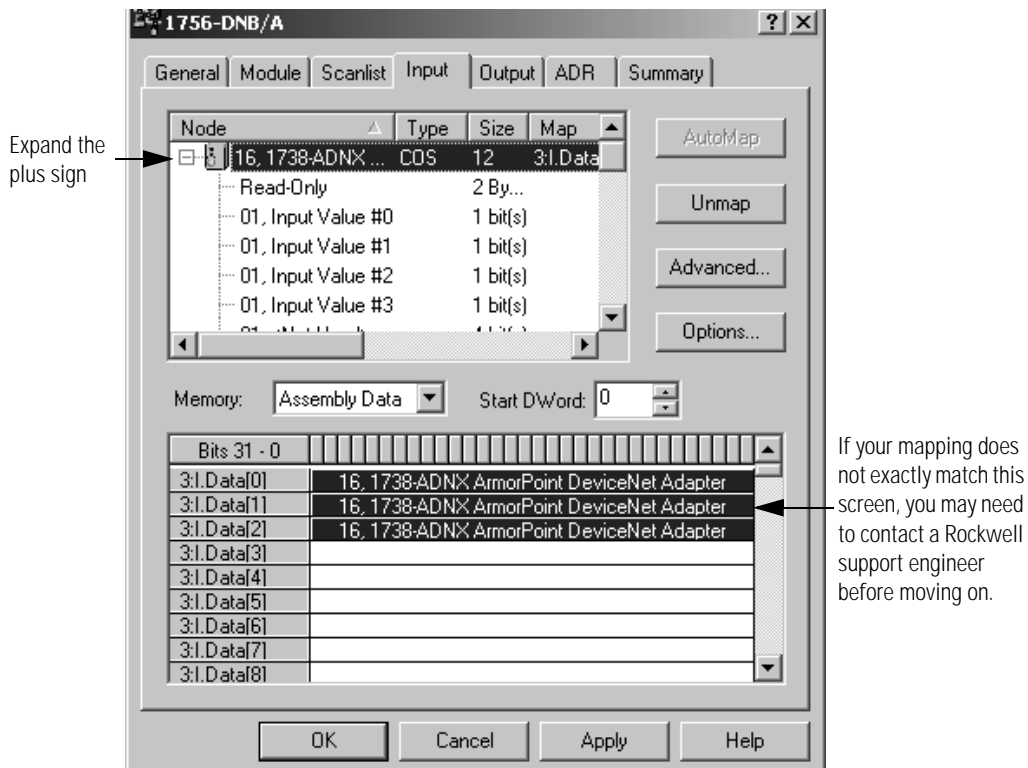

Now select the **Output** tab and find the bit for Output Value #1 on the 1734-OB4EM12. It should be **3:O.Data[0].17** as shown below. (NOTE: Hold your cursor in the box above the highlighted area to cause the last number to display.)

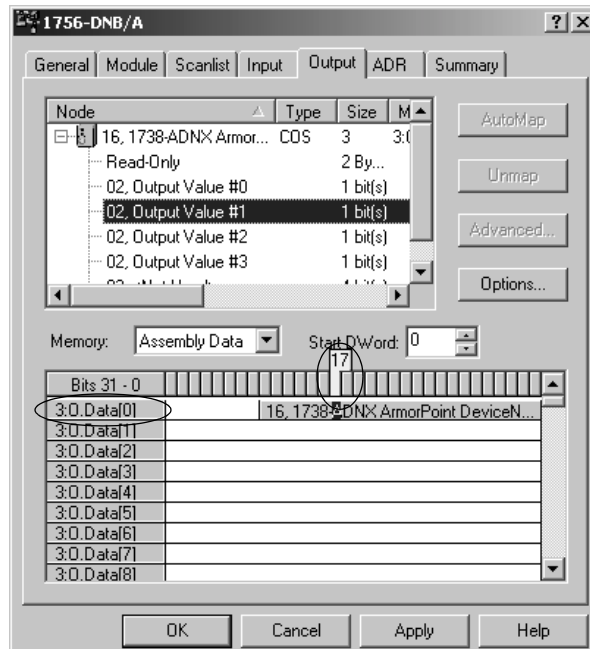

You are now ready to write your RSLogix5000 program.

18. Click **Apply**.
19. Click **Yes** when prompted to download these changes to the device.

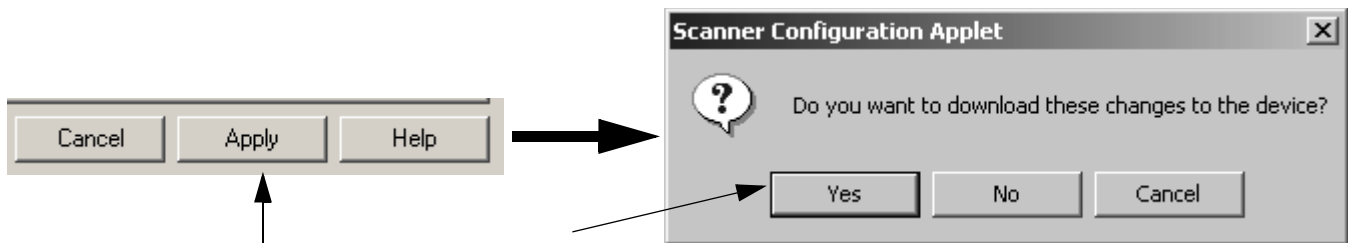

20. Click **OK** to close the 1756-DNB **Output** window.
21. **Exit** RSNetWorx for DeviceNet.

This is not a necessary step, but it will show you that RSLogix5000 can launch RSNetWorx for DeviceNet

22. When prompted to save, Click **Yes**.

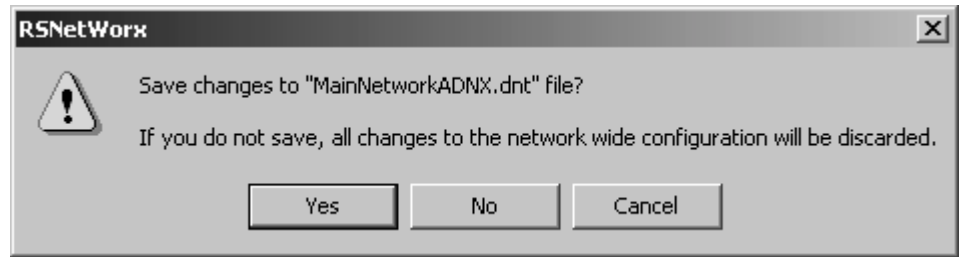

You have completed the 1738-ADNX Quick Start.

Notes:

Rules and Guidelines For the 1738-ADNX

RULE 1: A DeviceNet Subnet may not bridge directly to another DeviceNet Subnet. A 1738-ADNX may not be used on the Subnet of another 1738-ADNX.

NOTE: The 1738-ADNX will fault and report an error with any attempt to route message beyond the Subnet. It is not possible, therefore, to send explicit messages or browse through two 1738-ADNX adapters in series or through one 1738-ADNX and a network bridge device (or similar device) in series.

RULE 2: The aggregate sum of the primary DeviceNet trunk and its tributary Subnets cannot exceed the primary DeviceNet trunk scanner's I/O table size. The primary DeviceNet trunk scanner is the primary scanner, which provides data directly to the controller that owns the ArmorPoint I/O modules. For a complete list of scanners, refer to the RA Knowledgebase, Document # G32941961.

RULE 3: The 1738-ADNX Subnet is subject to all of the rules of ODVA requirements for DeviceNet compliant devices.

RULE 4: A DeviceNet Subnet may not bridge to any other network. Network is defined in this case as any communication link that is transmitting information from multiple devices to a single channel for further processing and transmission onto a separate network. A 1791D CompactBlock I/O module can be used on the Subnet of a 1738-ADNX, the other ArmorPoint DeviceNet adapters (1738-ADN12, -ADN18, and -ADN18P) cannot be used on the Subnet.

RULE 5: The 1738-ADNX DeviceNet Subnet is comprised of the adapter (always MACID 0), any backplane I/O modules and ODVA compliant devices attached to the lower DeviceNet connector.

RULE 6: The 1738-ADNX DeviceNet Subnet must be terminated, like any other DeviceNet network, according to ODVA specifications.

RULE 7: The EDS parameter, 'Max Backplane MACID' must be set so that it is not lower than that of any backplane modules. If no backplane modules are used, this value can be set to be 0, allowing modules 1-63 to be attached to the Subnet using DeviceNet cable.

RULE 8: Backplane modules are always addressed in increasing order from left to right. Gaps in the backplane addressing are permitted. Empty slots in the backplane are NOT permitted.

RULE 9: Subnet modules not on the backplane must always have or be assigned MACID's higher than those of the backplane modules.

RULE 10: Power must be supplied for non-backplane Subnet modules. The 1738-ADNX supplies only 5V dc power to the backplane ArmorPoint I/O modules, and 24V dc power to the non-backplane modules via the auxiliary power connector, pins 2 and 3.

RULE 11: The 1738-ADNX connection sizes may have to be manually entered into the primary DeviceNet network scanner device's scanlist (1756-DNB, 1747-SDN, etc.). Those connection sizes can be read from the EDS parameters 8-11 or deduced from the 1738-ADNX adapter's Subnet I/O mapping.

RULE 12: Explicit message requests will not transmit from the Subnet to the primary DeviceNet trunk. For example, a laptop computer connected to the Subnet with RSLinx will not be able to browse onto the primary DeviceNet.

RULE 13: Any master connected to the Subnet cannot own a ArmorPoint I/O module on the 1738-ADNX backplane.

RULE 14: The 1738-ADNX does not autobaud on the Subnet.

Default Data Maps

I/O messages are sent to (consumed) and received from (produced) the ArmorPoint I/O modules. These messages are mapped into the processor's memory. This appendix lists the default data maps for 1738 ArmorPoint I/O modules.

For the default data map of:	See page:
1738-IA2 Input Module	D-2
1738-IB2 Sink Input Module	D-2
1738-IB4 Sink Input Module	D-2
1738-IB8 Sink Input Module	D-3
1738-IV4 Source Input Module	D-3
1738-IV8 Source Input Module	D-3
1738-OA2 Output Module	D-4
1738-OB2E Electronically Protected Output Module	D-4
1738-OB2EP Protected Output Module	D-4
1738-OB4E Electronically Protected Output Module	D-5
1738-OB8E Electronically Protected Output Module	D-5
1738-OV4E Protected Sink Output Module	D-6
1738-OW4 Relay Sink/Source Output Module	D-6
1738-IE2C Analog Current Input Module	D-7
1738-IE2V Analog Input Module	D-8
1738-OE2C Analog Current Output Module	D-9
1738-OE2V Analog Output Module	D-9
1738-IJ Encoder/Counter Module	D-10
1738-IR2 RTD Input Module	D-10
1738-IT2I Isolated Thermocouple Input Module	D-11
1738-VHSC 24V dc High Speed Counter Module	D-12
1738-SSI Synchronous Serial Interface Absolute Encoder Module	D-12
1738-232ASC ASCII Module	D-13
1738-485ASC ASCII Module	D-13

1738-IA2 Input Module

Message size: 1 Byte

	7	6	5	4	3	2	1	0
Produces (scanner Rx)							Ch1	Ch0
Consumes (scanner Tx)	No consumed data							

Where: Ch0 = channel 0, Ch1 = channel 1; 0 = OFF, 1 = ON

1738-IB2 Sink Input Module

Message size: 1 Byte

	7	6	5	4	3	2	1	0
Produces (scanner Rx)							Ch1	Ch0
Consumes (scanner Tx)	No consumed data							

Where: Ch0 = channel 0, Ch1 = channel 1; 0 = OFF 1 = ON

1738-IB4 Sink Input Module

Message size: 1 Byte

	7	6	5	4	3	2	1	0
Produces (scanner Rx)					Ch3	Ch2	Ch1	Ch0
Consumes (scanner Tx)	No consumed data							

Where: Ch0 = input channel 0, Ch1 = input channel 1, Ch2 = input channel 2, Ch3 = channel 3; 0 = OFF 1 = ON

1738-IB8 Sink Input Module

Message size: 1 Byte

	7	6	5	4	3	2	1	0
Produces (scanner Rx)	Ch7	Ch6	Ch5	Ch4	Ch3	Ch2	Ch1	Ch0
Consumes (scanner Tx)	No consumed data							

Where: Ch0 = input channel 0, Ch1 = input channel 1, Ch2 = input channel 2, Ch3 = channel 3, Ch4 = input channel 4, Ch5 = input channel 5, Ch6 = input channel 6
Ch7 = channel 7; 0 = OFF, 1 = ON

1738-IV4 Source Input Module

Message size: 1 Byte

	7	6	5	4	3	2	1	0
Produces (scanner Rx)					Ch3	Ch1	Ch1	Ch0
Consumes (scanner Tx)	No consumed data							

Where: Ch0 = input channel 0, Ch1 = input channel 1, Ch2 = input channel 2, Ch3 = input channel 3; 0 = OFF, 1 = ON

1738-IV8 Source Input Module

Message size: 1 Byte

	7	6	5	4	3	2	1	0
Produces (scanner Rx)	Ch7	Ch6	Ch5	Ch4	Ch3	Ch2	Ch1	Ch0
Consumes (scanner Tx)	No consumed data							

Where: Ch0 = input channel 0, Ch1 = input channel 1, Ch2 = input channel 2, Ch3 = input channel 3, Ch4 = input channel 4, Ch5 = input channel 5, Ch6 = input channel 6,
Ch7 = input channel 7; 0 = OFF, 1 = ON

1738-OA2 Output Module

Message size: 1 Byte

	7	6	5	4	3	2	1	0	
Produces (scanner Rx)	No produced data								
Consumes (scanner Tx)	Not used						Ch1	Ch0	Channel state
Where: Ch0 = output channel 0, Ch1 = output channel 1; 0 = OFF, 1 = ON									

1738-OB2E Electronically Protected Output Module

Message size: 1 Byte

	7	6	5	4	3	2	1	0	
Produces (scanner Rx)	Not used						Ch1	Ch0	Channel status
Where: Ch0 = output channel 0, Ch1 = output channel 1; 0 = no error 1 = error									

Message size: 1 Byte

	7	6	5	4	3	2	1	0	
Consumes (scanner Tx)	Not used						Ch1	Ch0	Channel state
Where: Ch0 = output channel 0, Ch1 = output channel 1; 0 = OFF 1 = ON									

1738-OB2EP Protected Output Module

Message size: 1 Byte

	7	6	5	4	3	2	1	0	
Produces (scanner Rx)	Not used						Ch1	Ch0	Channel status
Where: Ch0 = output channel 0, Ch1 = output channel 1; 0 = no error 1 = error									

Message size: 1 Byte

	7	6	5	4	3	2	1	0	
Consumes (scanner Tx)	Not used						Ch1	Ch0	Channel state
Where: Ch0 = output channel 0, Ch1 = output channel 1; 0 = OFF 1 = ON									

1738-OB4E Electronically Protected Output Module

Message size: 1 Byte

	7	6	5	4	3	2	1	0	
Produces (scanner Rx)	Not used				Ch3	Ch2	Ch1	Ch0	Channel status

Where: Ch0 = output channel 0, Ch1 = output channel 1, Ch2 = output channel 2, Ch3 = output channel 3; 0 = no error 1 = error

Message size: 1 Byte

	7	6	5	4	3	2	1	0	
Consumes (scanner Tx)	Not used				Ch3	Ch2	Ch1	Ch0	Channel state

Where: Ch0 = output channel 0, Ch1 = output channel 1, Ch2 = output channel 2, Ch3 = output channel 3; 0 = OFF 1 = ON

1738-OB8E Electronically Protected Output Module

Message size: 1 Byte

	7	6	5	4	3	2	1	0	
Produces (scanner Rx)	Ch7	Ch6	Ch5	Ch4	Ch3	Ch2	Ch1	Ch0	Channel status

Where: Ch0 = output channel 0, Ch1 = output channel 1, Ch2 = output channel 2, Ch3 = output channel 3, Ch4 = output channel 4, Ch5 = output channel 5, Ch6 = output channel 6, Ch7 = output channel 7; 0 = no error 1 = error

Message size: 1 Byte

	7	6	5	4	3	2	1	0	
Consumes (scanner Tx)	Ch7	Ch6	Ch5	Ch4	Ch3	Ch2	Ch1	Ch0	Channel state

Where: Ch0 = output channel 0, Ch1 = output channel 1, Ch2 = output channel 2, Ch3 = output channel 3, Ch4 = output channel 4, Ch5 = output channel 5, Ch6 = output channel 6, Ch7 = output channel 7; 0 = OFF 1 = ON

1738-OV4E Protected Sink Output Module

Message size: 1 Byte

	7	6	5	4	3	2	1	0	
Produces (scanner Rx)	Not used				Ch3	Ch2	Ch1	Ch0	Channel status

Where: Ch0 = output channel 0, Ch1 = output channel 1, Ch2 = output channel 2, Ch3 = output channel 3; 0 = no error 1 = error

Message size: 1 Byte

	7	6	5	4	3	2	1	0	
Consumes (scanner Tx)	Not used				Ch3	Ch2	Ch1	Ch0	Channel state

Where: Ch0 = output channel 0, Ch1 = output channel 1, Ch2 = output channel 2, Ch3 = output channel 3; 0 = OFF 1 = ON

1738-OW4 Relay Sink/Source Output Module

Message size: 1 Byte

	7	6	5	4	3	2	1	0	
Consumes (scanner Tx)	Not used				Ch3	Ch2	Ch1	Ch0	Channel state

Where: Ch0 = output channel 0, Ch1 = output channel 1, Ch2 = output channel 2, Ch3 = output channel 3; 0 = OFF 1 = ON

1738-IE2C Analog Current Input Module

Message size: 6 Bytes

	15	14	13	12	11	10	09	08	07	06	05	04	03	02	01	00
Produces (scanner Rx)	Input Channel 0 High Byte								Input Channel 0 Low Byte							
	Input Channel 1 High Byte								Input Channel 1 Low Byte							
	Status Byte for Channel 1								Status Byte for Channel 0							
	OR	UR	HHA	LLA	HA	LA	CM	CF	OR	UR	HHA	LLA	HA	LA	CM	CF
Consumes (scanner Tx)	No consumed data															

Where: CF = Channel Fault status; 0 = no error, 1 = fault

CM = Calibration Mode; 0 = normal, 1 = calibration mode

LA = Low Alarm; 0 = no error, 1 = fault

HA = High Alarm; 0 = no error, 1 = fault

LLA = Low/Low Alarm; 0 = no error, 1 = fault

HHA = High/High Alarm; 0 = no error, 1 = fault

UN = Underrange; 0 = no error, 1 = fault

OR = Overrange; 0 = no error, 1 = fault

1738-IE2V Analog Input Module

Message size: 6 Bytes

	15	14	13	12	11	10	09	08	07	06	05	04	03	02	01	00
Produces (scanner Rx)	Input Channel 0 - High Byte								Input Channel 0 - Low Byte							
	Input Channel 1 - High Byte								Input Channel 1 - Low Byte							
	Status Byte for Channel 1								Status Byte for Channel 0							
	OR	UR	HHA	LLA	HA	LA	CM	CF	OR	UR	HHA	LLA	HA	LA	CM	CF
Consumes (scanner Tx)	No consumed data															

Where: CF = Channel Fault status; 0 = no error, 1 = fault
 CM = Calibration Mode; 0 = normal, 1 = calibration mode
 LA = Low Alarm; 0 = no error, 1 = fault
 HA = High Alarm; 0 = no error, 1 = fault
 LLA = Low/Low Alarm; 0 = no error, 1 = fault
 HHA = High/High Alarm; 0 = no error, 1 = fault
 UR = Underrange; 0 = no error, 1 = fault
 OR = Overrange; 0 = no error, 1 = fault

1738-OE2C Analog Current Output Module

Message size: 4 bytes

	15	14	13	12	11	10	09	08	07	06	05	04	03	02	01	00
Consumes (Tx)	Output Channel 0 High Byte								Output Channel 0 Low Byte							
	Output Channel 1 High Byte								Output Channel 1 Low Byte							

Message size: 2 Bytes

	15	14	13	12	11	10	09	08	07	06	05	04	03	02	01	00
Produces (Rx)	High Byte - Channel 1 Status								Low Byte - Channel 0 Status							
	Not used				HCA	LCA	CM	CF	Not used				HCA	LCA	CM	CF

Where: CF = Channel Fault status; 0 = no error, 1 = fault

CM = Calibration Mode; 0 = normal, 1 = calibration mode

LCA = Low Clamp Alarm; 0 = no error, 1 = fault

HCA = High Clamp Alarm; 0 = no error, 1 = fault

1738-OE2V Analog Output Module

Message size: 2 Bytes

	15	14	13	12	11	10	09	08	07	06	05	04	03	02	01	00
Produces (scanner Rx)	Channel 1 Status - High Byte								Channel 0 Status - Low Byte							
	Not used				HCA	LCA	CM	ST	Not used				HCA	LCA	CM	ST

Where: ST = Channel Fault Status; 0 = no error, 1 = fault

CM = Calibration Mode; 0 = normal, 1 = calibration mode

LCA = Low Clamp Alarm; 0 = no error, 1 = fault

HCA = High Clamp Alarm; 0 = no error, 1 = fault

1738-IJ Encoder/Counter Module

Message size: 6 Bytes

	15	14	13	12	11	10	09	08	07	06	05	04	03	02	01	00
Produces (scanner Rx)	Channel 0 value of present counter state (LSW)															
	Channel 0 value of present counter state (MSW)															
	PE	EF	NR	0	0	0	0	0	0	ZS	BS	AS	C1	C0	ZD	0

- Where: PE = Programming error
 EF = EEPROM fault status
 NR = Not ready status bit
 ZS = Z input status
 BS = B input status
 AS = A input status
 C = Stored data count
 ZD = Zero frequency detected
 LSW = Least significant word
 MSW= Most significant word

1738-IR2 RTD Input Module

Message size: 6 Bytes

	15	14	13	12	11	10	09	08	07	06	05	04	03	02	01	00
Produces (scanner Rx)	Input Channel 0 - High Byte								Input Channel 0 - Low Byte							
	Input Channel 1 - High Byte								Input Channel 1 - Low Byte							
	Status Byte for Channel 1								Status Byte for Channel 0							
	OR	UR	HHA	LLA	HA	LA	CM	CF	OR	UR	HHA	LLA	HA	LA	CM	CF
Consumes (scanner Tx)	No consumed data															

- Where: CF = Channel Fault status; 0 = no error, 1 = fault
 CM = Calibration Mode; 0 = normal, 1 = calibration mode
 LA = Low Alarm; 0 = no error, 1 = fault
 HA = High Alarm; 0 = no error, 1 = fault
 LLA = Low/Low Alarm; 0 = no error, 1 = fault
 HHA = High/High Alarm; 0 = no error, 1 = fault
 UR = Underrange; 0 = no error, 1 = fault
 OR = Overrange; 0 = no error, 1 = fault

1738-IT2I Isolated Thermocouple Input Module

Message size: 8 Bytes

	15	14	13	12	11	10	09	08	07	06	05	04	03	02	01	00
Produces (scanner Rx)	Input Channel 0 - High Byte								Input Channel 0 - Low Byte							
	Input Channel 1 - High Byte								Input Channel 1 - Low Byte							
	Status Byte for Channel 1								Status Byte for Channel 0							
	OR	UR	HHA	LLA	HA	LA	CM	CF	OR	UR	HHA	LLA	HA	LA	CM	CF
	OR	UR	Cold Junction Temperature (Selectable: Channel 0, Channel 1, or Average of both Channel 0 and 1)													
Consumes (scanner Tx)	No consumed data															

Where: CF = Channel Fault status; 0 = no error, 1 = fault

CM = Calibration Mode; 0 = normal, 1 = calibration mode

LA = Low Alarm; 0 = no error, 1 = fault

HA = High Alarm; 0 = no error, 1 = fault

LLA = Low/Low Alarm; 0 = no error, 1 = fault

HHA = High/High Alarm; 0 = no error, 1 = fault

UR = Underrange; 0 = no error, 1 = fault

OR = Ovrerrange; 0 = no error, 1 = fault

1738-VHSC 24V dc High Speed Counter Module

Message size: 6 Bytes

	15	14	13	12	11	10	09	08	07	06	05	04	03	02	01	00
Produces (scanner Rx)	Channel 0 value of present counter state (LSW)															
	Channel 0 value of present counter state (MSW)															
	PE	EF	NR	0	FS	FS	OS	OS	0	ZS	BS	AS	C1	C0	ZD	0

Where: PE = Programming error

EF = EEPROM fault status

NR = Not ready status bit

FS = Output fault status bit - bit 10 for output 0, bit 11 for output 1

OS = Output on/off status bit - bit 8 for output 0, bit 9 for output 1

ZS = Z input status

BS = B input status

AS = A input status

C = Stored data count

ZD = Zero frequency detected

LSW = Least significant word

MSW = Most significant word

1738-SSI Synchronous Serial Interface Absolute Encoder Module

	7	6	5	4	3	2	1	0	
Produce 8	C2ST	C1ST	C2R	C1R	INC	DEC	RUN	I1	Status Byte 0 ¹
Produce 9	RES	RES	RES	LHON	IDF ²	CCE	CCF	SPF	Status Byte 1 ¹

1. For detailed descriptions of these bits, see 1738-SSI User Manual, publication 1738-UM009.

2. Monitor IDF to determine the validity of the produced data. If IDF=1, the SSI data is false.

	7	6	5	4	3	2	1	0	
Consume 0	RES	RES	RES	SCMP2	SCMP1	CC2	CC1	LACK	Master ACK Byte ^{1,3}
Consume 1	RES	RES	RES	RES	RES	RES	RES	RES	CONS ¹

3. The master must provide the Master ACK Byte in order to receive the polled Produced bytes 0-9.

1738-232ASC ASCII Module

Default Receive Data Assembly Format (Default Mode)

Byte 1	Byte 2	Byte 3	Byte 4	Byte 5-23	Byte 24
Rx Transaction ID Byte	Status Byte	Reserved	Length	ASCII Data	<CR> (Terminator)

Default Transmit Data Assembly Format (Default Mode)

Byte 1	Byte 2	Byte 3	Byte 4	Byte 5-23	Byte 24
Reserved	TX Transaction ID Byte	Reserved	Length	ASCII Data	<CR> (Terminator)

1738-485ASC ASCII Module

Default Receive Data Assembly Format (Default Mode)

Byte 1	Byte 2	Byte 3	Byte 4	Byte 5-23	Byte 24
Rx Transaction ID Byte	Status Byte	Reserved	Length	ASCII Data	<CR> (Terminator)

Default Transmit Data Assembly Format (Default Mode)

Byte 1	Byte 2	Byte 3	Byte 4	Byte 5-23	Byte 24
Reserved	TX Transaction ID Byte	Reserved	Length	ASCII Data	<CR> (Terminator)

Notes:

Numbers

1734-IV8 data map D-3
1738-232ASC data map D-13
1738-485ASC data map D-13
1738-ADNX
 MACID parameter B-9
 rules on how to use C-1
1738-ADNX quick start B-1
 assumptions B-1
 browse the subnet B-15
 inputs and outputs B-19
 navigate between networks B-24
 review 1738-ADNX rules B-9
 review auto start mode B-11
 switch between networks B-26
1738-IA2 data map D-2
1738-IB2 data map D-2
1738-IB4 data map D-2, D-3
1738-IE2V data map D-8
1738-IEC2 data map D-7
1738-IJ data map D-10
1738-IR2 data map D-10
1738-IT2I data map D-11
1738-IV8 data map D-3
1738-OA2 data map D-4
1738-OB2E data map D-4
1738-OB2EP data map D-4
1738-OB4E data map D-5
1738-OB8E data map D-5
1738-OE2C data map D-9
1738-OE2V data map D-9
1738-OV4E data map D-6
1738-OW4 data map D-6
1738-SSI data map D-12
1738-VHSC24 data map D-12

A

adapter

adding to network 5-2
 auto start 5-4
 autoaddress 5-4
 autoaddress backplane modules 5-4
 backplane autobaud 5-4
 backplane baudrate 5-4
 configuration overview 5-1
 device bridging 5-4
 going on line 5-6
 guidelines for using 6-3
 I/O data parameter 5-5

parameters 5-4
 residence on two networks
 simultaneously 2-2
 setting backplane baudrate 5-4
 setting parameters 5-3
 using 2-2
 what it is? 2-1

adapter features

auto address 2-13
 auto catalog replace 2-10
 auto start mode 2-9
 automatic device replacement 2-15
 backplane autobaud 2-12
 backplane baudrate 2-10
 COS connection produce size 2-14
 cycling I/O mapping 2-15
 cycling node status 2-14
 expected packet rate 2-17
 field upgradable firmware 2-8
 foreground to background poll ratio 2-17
 fully software configurable 2-8
 interscan delay 2-17
 multiple baudrates 2-9
 multiple connection types 2-8
 physical list acquire status 2-13
 physical ordering 2-16
 poll/COS connection consume size 2-14
 self-test 2-8
 strobe connection produce size 2-14
 transmit retries 2-18

adapters

guidelines for use P-6
 wiring 1-3

associated network

B-26

audience for manual

P-1

auto catalog replace

of adapter when power applied 2-10

auto start

adapter 5-4

auto start mode

beginning 3-7
 byte boundaries 3-3
 double word boundaries 3-3
 fixed boundaries 3-3
 mapping I/O data 3-3
 of adapter when power applied 2-9
 requirements to using 3-4
 using 3-1
 what it does 3-2
 why use? 3-2
 word boundaries 3-3

auto start mode review

1738-ADNX B-11

autoaddress 2-13

adapter 5-4

enabling in RSNetWorx for DeviceNet
5-4**autoaddress backplane modules**

adapter 5-4

autobaud P-3, 2-9**automatic device replacement 2-15****automatic device replacement via
PointBus 2-18****B****backplane**

set I/O module address 2-3

backplane autobaud 2-12

adapter 5-4

enabling in RSNetWorx for DeviceNet
5-4**backplane baudrate 2-10**

adapter 5-4

setting 2-3

setting in RSNetWorx for DeviceNet 5-4

backplane network 2-7**baudrate P-3, 2-9****browse the network**

1738-ADNX B-15

byte boundaries 3-3**C****change of state (COS) P-3, 2-6, 2-23****collecting data on PointBus 2-7****communicate through the adapter 2-18****communications**

communicating with I/O modules 2-23

image table mapping 2-20

mapping data 2-18

overview of the process 2-19

configuration

adapter overview 5-1

adding adapter to network 5-2

adding I/O modules to network 4-3

adding scanner to network 4-2

configuring scanner subnet 4-1

configuring the adapter for DeviceNet
5-1

going on line 4-8, 5-6

RSNetWorx for DeviceNet P-1, P-4

setting the adapter's parameters 5-3

setting the scanner's parameters 4-3

using EDS files 5-5

**configure the primary DeviceNet
network 2-4****configure the subnet I/O 2-3****connections**

to and from the adapter 2-8

contents of manual P-2**ControlFlash P-3, 2-8****conventions used in manual P-6****COS connection produce size 2-14****custom configuration**

using 3-9

cyclic P-4, 2-6, 2-23**cycling I/O mapping 2-15****D****data alignment**scanner setting in RSNetWorx for
DeviceNet 4-6**data collection**

on PointBus 2-7

data maps

1738-232ASC D-13

1738-485ASC D-13

1738-IA2 D-2

1738-IB2 D-2

1738-IB4 D-2, D-3

1738-IE2C D-7

1738-IE2V D-8

1738-IJ D-10

1738-IR2 D-10

1738-IT2I D-11

1738-IV4 D-3

1738-IV8 D-3

1738-OA2 D-4

1738-OB2E D-4

1738-OB2EP D-4

1738-OB4E D-5

1738-OB8E D-5

1738-OE2C D-9

1738-OE2V D-9

1738-OV4E D-6

1738-OW4 D-6

1738-SSI D-12

1738-VHSC24 D-12

default D-1

data tables

faulted node table 2-24

idle node table 2-24

node status table 2-24

default data maps D-1
device bridging 5-4
DeviceNet communications
 backplane autobaud 2-12
 backplane baudrate 2-10
 change of state P-3, 2-6, 2-23
 cyclic P-4, 2-6, 2-23
 polled P-4, 2-6, 2-23
 strobe P-4, 2-6, 2-23
DeviceNet network 2-6
 remove and reinsert modules 2-5
 RSNetwork for DeviceNet 2-2
 understanding 2-6
DeviceNet network, primary
 configure 2-4
diagnostic tables 2-24
documentation
 other ArmorPoint I/O products 2-7, P-5
double word boundaries 3-3

E

EDS Files 5-5
expansion power unit (1738-EP24DC) 2-7
expected packet rate 2-17
 scanner setting in RSNetWorx for
 DeviceNet 4-5

F

faulted node table 2-24
firmware
 upgrading in the field 2-8
fixed boundaries 3-3
foreground to background poll ratio 2-17
 scanner setting in RSNetWorx for
 DeviceNet 4-5

G

going on line 4-8, 5-6
guidelines
 using 1738-ADNX C-1
 using the adapter 6-3
guidelines for using the adapter P-6

I

I/O data parameter
 adapter 5-5
I/O modules
 installing 3-4
 removing from mounting base 3-5
I/O status word bit 2-22
idle node table 2-24
image table mapping 2-20
inputs and outputs
 1738-ADNX B-19
installing
 I/O modules 3-4
installing the adapter 1-1
interscan delay 2-17
 scanner setting in RSNetWorx for
 DeviceNet 4-5

M

MACID parameter B-9
map from parameters
 scanner setting in RSNetWorx for
 DeviceNet 4-6
mapping data 2-18
mapping I/O data
 in auto start mode 3-3
module power 2-7
mount the adapter 1-1
mount the I/O base 1-1
mounting base
 removing I/O modules 3-5

N

navigate between networks
 1738-ADNX B-24
networks 2-2
 DeviceNet 2-6, 2-18
 PointBus 2-18
node address
 setting 1-2
node status
 cycling 2-14
node status table 2-24

O

on line
 going 4-8, 5-6

P

parameters

- 1738-ADNX MACID B-9
- adapter 5-4
- foreground to background poll ratio 4-5
- I/O data, adapter 5-5
- map from scanner 4-6
- scanner 4-3
- scanner data alignment 4-6
- scanner expected packet rate setting 4-5
- scanner interscan delay 4-5
- scanner transmit retries 4-5
- setting adapter 5-3

physical list acquire status 2-13

physical ordering 2-16

PointBus 2-2

- data collection 2-7

poll/COS connection consume size 2-14

polled P-4, 2-6, 2-23

power

- expansion power unit 2-7
- supplying power to ArmorPoint I/O modules 2-7

primary DeviceNet network

- configure 2-4

products related to adapters P-5

products related to ArmorPoint I/O

products P-5

purpose of manual P-1

Q

quick start

- 1738-ADNX B-1

R

related documentation P-5, 2-7

related products P-5

related terms P-3

remove and reinsert modules on

DeviceNet network 2-5

removing I/O base from mounting base 3-5

review

- 1738-ADNX rules B-9

RSNetWorx for DeviceNet P-4, 3-5, 4-1, 5-1

- using 3-5

RSNetWorx for DeviceNet software P-1

rules

- using 1738-ADNX C-1

S

scanner

- adding I/O modules to network 4-3
- adding to network 4-2
- configuration overview 4-1
- data alignment 4-6
- expected packet rate setting 4-5
- foreground to background poll ratio 4-5
- going on line 4-8
- interscan delay 4-5
- setting parameters 4-3
- settings in RSNetWorx for DeviceNet 4-6
- transmit retries 4-5

self-test

- of adapter when power applied 2-8

set backplane baudrate 2-3

set backplane I/O module address 2-3

set node address 1-2

set subnet baudrate 2-3

set subnet I/O module address 2-3

software

- Configuring scanner subnet 4-1
- configuring the adapter for DeviceNet 5-1
- RSNetWorx for DeviceNet P-1, P-4, 2-8, 3-5

specifications A-1

status indicators 6-1

strobe P-4, 2-6, 2-23

strobe connection produce size 2-14

subnet

- configure I/O 2-3
- set I/O module address 2-3
- understanding 2-6

subnet baudrate

- setting 2-3

subnet network 2-7

switch between networks B-26

T

terminal marking kits P-6

terms defined P-3

terms used in manual P-3

transmit retries 2-18

scanner setting in RSNetWorx for
DeviceNet 4-5

troubleshooting

using status indicators 6-1

U

updating adapter firmware

using the ControlFlash utility P-3

using diagnostic tables 2-24

using the adapters

guidelines P-6

W

wire the adapters 1-3

word boundaries 3-3



How Are We Doing?

Your comments on our technical publications will help us serve you better in the future. Thank you for taking the time to provide us feedback.

You can complete this form and mail it back to us, visit us online at www.ab.com/manuals, or email us at RADocumentComments@ra.rockwell.com

Pub. Title/Type ArmorPoint I/O DeviceNet Adapters

Cat. No. 1738-ADN12, -ADN18, -ADN18P, -ADNX Pub. No. 1738-UM001A-EN-P Pub. Date February 2005 Part No. 957899-58

Please complete the sections below. Where applicable, rank the feature (1=needs improvement, 2=satisfactory, and 3=outstanding).

Overall Usefulness 1 2 3	How can we make this publication more useful for you?			
Completeness (all necessary information is provided)	1 2 3	Can we add more information to help you?		
		procedure/step	illustration	feature
		example	guideline	other
		explanation	definition	
Technical Accuracy (all provided information is correct)	1 2 3	Can we be more accurate?		
		text	illustration	
Clarity (all provided information is easy to understand)	1 2 3	How can we make things clearer?		
Other Comments	You can add additional comments on the back of this form.			

Your Name _____
Your Title/Function _____

Location/Phone _____
Would you like us to contact you regarding your comments?

- No, there is no need to contact me
- Yes, please call me
- Yes, please email me at _____
- Yes, please contact me via _____

Return this form to: Allen-Bradley Marketing Communications, 1 Allen-Bradley Dr., Mayfield Hts., OH 44124-9705
Phone: 440-646-3176 Fax: 440-646-3525 Email: RADocumentComments@ra.rockwell.com

PLEASE FASTEN HERE (DO NOT STAPLE)

Other Comments

PLEASE FOLD HERE

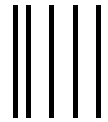

NO POSTAGE
NECESSARY
IF MAILED
IN THE
UNITED STATES

PLEASE REMOVE

BUSINESS REPLY MAIL

FIRST-CLASS MAIL PERMIT NO. 18235 CLEVELAND OH

POSTAGE WILL BE PAID BY THE ADDRESSEE



**Rockwell
Automation**

**1 ALLEN-BRADLEY DR
MAYFIELD HEIGHTS OH 44124-9705**

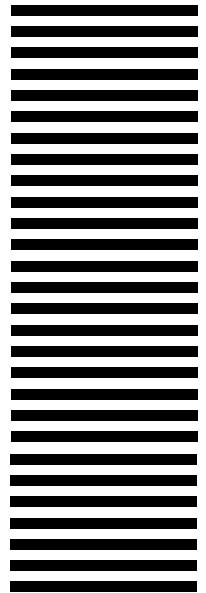

Rockwell Automation Support

Rockwell Automation provides technical information on the web to assist you in using our products. At <http://support.rockwellautomation.com>, you can find technical manuals, a knowledge base of FAQs, technical and application notes, sample code and links to software service packs, and a MySupport feature that you can customize to make the best use of these tools.

For an additional level of technical phone support for installation, configuration and troubleshooting, we offer TechConnect Support programs. For more information, contact your local distributor or Rockwell Automation representative, or visit <http://support.rockwellautomation.com>.

Installation Assistance

If you experience a problem with a hardware module within the first 24 hours of installation, please review the information that's contained in this manual. You can also contact a special Customer Support number for initial help in getting your module up and running:

United States	1.440.646.3223 Monday – Friday, 8am – 5pm EST
Outside United States	Please contact your local Rockwell Automation representative for any technical support issues.

New Product Satisfaction Return

Rockwell tests all of our products to ensure that they are fully operational when shipped from the manufacturing facility. However, if your product is not functioning and needs to be returned:

United States	Contact your distributor. You must provide a Customer Support case number (see phone number above to obtain one) to your distributor in order to complete the return process.
Outside United States	Please contact your local Rockwell Automation representative for return procedure.

RSNetWorx for DeviceNet, DeviceNetManager, PointBus, ControlFlash, and ArmorPoint I/O are trademarks of Rockwell Automation. DeviceNet is a trademark of Open DeviceNet Vendor Association.

www.rockwellautomation.com

Power, Control and Information Solutions Headquarters

Americas: Rockwell Automation, 1201 South Second Street, Milwaukee, WI 53204-2496 USA, Tel: (1) 414.382.2000, Fax: (1) 414.382.4444

Europe/Middle East/Africa: Rockwell Automation, Vorstlaan/Boulevard du Souverain 36, 1170 Brussels, Belgium, Tel: (32) 2 663 0600, Fax: (32) 2 663 0640

Asia Pacific: Rockwell Automation, Level 14, Core F, Cyberport 3, 100 Cyberport Road, Hong Kong, Tel: (852) 2887 4788, Fax: (852) 2508 1846